

1719 Ex I/O

Catalog Numbers 1719-AENTR, 1719-IJ, 1719-IBN8B, 1719-IF4HB, 1719-IR4B, 1719-IT4B, 1719-OB2, 1719-OB2L, 1719-CF4H, 1719-PSDC, 1719-A22, 1719-A8, 1719-A24, 1719-TB6, 1719-TB6S, 1719-TB8, 1719-TB8S, 1719-TB8Sx2, 1719-TB8x2, 1719-CBL, 1719-ARM



Important User Information

Read this document and the documents listed in the additional resources section about installation, configuration, and operation of this equipment before you install, configure, operate, or maintain this product. Users are required to familiarize themselves with installation and wiring instructions in addition to requirements of all applicable codes, laws, and standards.

Activities including installation, adjustments, putting into service, use, assembly, disassembly, and maintenance are required to be carried out by suitably trained personnel in accordance with applicable code of practice.

If this equipment is used in a manner not specified by the manufacturer, the protection provided by the equipment may be impaired.

In no event will Rockwell Automation, Inc. be responsible or liable for indirect or consequential damages resulting from the use or application of this equipment.

The examples and diagrams in this manual are included solely for illustrative purposes. Because of the many variables and requirements associated with any particular installation, Rockwell Automation, Inc. cannot assume responsibility or liability for actual use based on the examples and diagrams.

No patent liability is assumed by Rockwell Automation, Inc. with respect to use of information, circuits, equipment, or software described in this manual.

Reproduction of the contents of this manual, in whole or in part, without written permission of Rockwell Automation, Inc., is prohibited.

Throughout this manual, when necessary, we use notes to make you aware of safety considerations.



WARNING: Identifies information about practices or circumstances that can cause an explosion in a hazardous environment, which may lead to personal injury or death, property damage, or economic loss.



ATTENTION: Identifies information about practices or circumstances that can lead to personal injury or death, property damage, or economic loss. Attentions help you identify a hazard, avoid a hazard, and recognize the consequence.

IMPORTANT

Identifies information that is critical for successful application and understanding of the product.

Labels may also be on or inside the equipment to provide specific precautions.



SHOCK HAZARD: Labels may be on or inside the equipment, for example, a drive or motor, to alert people that dangerous voltage may be present.



BURN HAZARD: Labels may be on or inside the equipment, for example, a drive or motor, to alert people that surfaces may reach dangerous temperatures.



ARC FLASH HAZARD: Labels may be on or inside the equipment, for example, a motor control center, to alert people to potential Arc Flash. Arc Flash will cause severe injury or death. Wear proper Personal Protective Equipment (PPE). Follow ALL Regulatory requirements for safe work practices and for Personal Protective Equipment (PPE).

Summary of Changes

This manual contains new and updated information. Changes throughout this revision are marked by change bars, as shown to the right of this paragraph.

Topic	Page
Added a link to the 1719 Certification Bulletin	9
Added information about the required EtherNet/IP connection per module	22
Updated the number of I/O modules an adapter can control from 45 to 46	23
Added Important table with information about power consumption	23
Revised the Analog Module Selection Guide section	30
Revised the Power Supplies section	33
Added the Addressing with 1719 Ex I/O section	40

Notes:

Preface	Who Should Use This Manual	9
	Purpose of This Manual	9
	Additional Resources	9
	 Chapter 1	
Safety	Validity	11
	Used Symbols	11
	Target Group, Personnel	11
	Reference to Further Documentation	12
	Marking	12
	Intended Use	13
	Improper Use	13
	Mounting and Installation	13
	Additional Requirements for Cables and Connection Lines . . .	14
	Surrounding Enclosure	15
	Operation, Maintenance, Repair	15
	Delivery, Transport, Disposal	15
	 Chapter 2	
Product Specifications	Introduction	18
	1719 Ex I/O Components	19
	1719 Ex I/O Components Overview	19
	Backplanes	20
	Function	20
	Design and Dimensions	20
	Side View	21
	Backplane Combinations	22
	Backplane and Module Compatibility	22
	Scope of Delivery	22
	Adapter	23
	Function	23
	Adapter Components	23
	Adapter Considerations	24
	EtherNet/IP Network	24
	Use the Module on a Device Level Ring Network	24
	1719-AENTR LCD Screen	25
	I/O Modules and Power Supplies	28
	Function	28
	Design and Dimensions	29
	Analog Module Selection Guide	30
	Digital Output Module Selection Guide	30
	Power Supplies	33
	Accessories	33
	Field Wiring	33

	Chapter 3	
Commissioning	Electrical Testing of Connections.....	37
	Testing and Addressing the EtherNet/IP Connection	37
	Configuration	37
	Startup Phase	38
	Temporary Overload of the Power Supply	38
	Chapter 4	
Operation	Ownership	39
	Configure a 1719 Ex I/O System	39
	Connections	40
	Addressing with 1719 Ex I/O.....	40
	Chapter 5	
1719 Ex I/O HART Analog I/O Modules	HART Communication.....	44
	Integrated HART Networks	45
	HART-enabled I/O Modules	45
	Asset Management Software	45
	HART Device Info Tab	46
	Set Device Info (1719-IF4HB, 1719-CF4H).....	49
	HART Command Tab -	
	1719-IF4HB, 1719-CF4H.....	50
	Data in the Input Tags.....	50
	HART Dynamic Variables	51
	How the Module Automatically Collects Data	53
	Getting HART Data by Using CIP MSG	56
	HART Modules Used with Asset Management Software	56
	Considerations for Asset Management Systems	56
Frequently Asked Questions.....	56	
	Appendix A	
Troubleshooting	Communication Errors.....	59
	Signal Faults	60
	Appendix B	
Technical Data	Power Supply	61
	Mechanical Data	61
	Ambient Conditions	62
	Appendix C	
Additional HART Protocol Information	Message Structure	64
	Master-slave Operation	64
	Multiple Master Operation.....	64
	Transaction Procedure.....	64

Burst Mode 64
 Response Code and
 Field Device Status 65
 HART PV, SV, TV, and FV Status 71

Appendix D

Engineering Unit Code Numbers

Code Number Details 75

Notes:

Read this preface to familiarize yourself with the rest of the manual. It provides information concerning:

- who should use this manual
- the purpose of this manual
- related documentation
- supporting information

Who Should Use This Manual

This manual is intended for trained and qualified personnel who are responsible for mounting, installation, commissioning, operation, maintenance, and disassembly of 1719 Ex I/O.

For more information, see [Target Group, Personnel on page 11](#).

Purpose of This Manual

This manual provides information and describes the procedures that are used to install, wire, troubleshoot, and operate 1719 Ex I/O.

Additional Resources

These resources contain information about related products from Rockwell Automation.

Resource	Description
1719 Ex I/O Installation Instructions, publication 1719-IN001	Describes how to install and wire the 1719 Ex I/O input and output modules
1719 Ex I/O Technical Data, publication 1719-TD001	Provides specifications, wiring diagrams, and module block diagrams for 1719 Ex I/O
Industrial Automation Wiring and Grounding Guidelines, publication 1770-4.1	Provides general guidelines for installing a Rockwell Automation industrial system.
1719 Certification Bulletin, publication 1719-CT001	Provides 1719 Ex I/O certification information and links to control drawings.

You can view or download publications at <http://literature.rockwellautomation.com/>. For Release Notes and other publications specific to your module, search the catalog number of the module. To order paper copies of technical documentation, contact your local Allen-Bradley distributor or Rockwell Automation sales representative.

Notes:

Safety

Topic	Page
Validity	11
Used Symbols	11
Target Group, Personnel	11
Reference to Further Documentation	12
Marking	12
Intended Use	13
Improper Use	13
Mounting and Installation	13
Surrounding Enclosure	15
Operation, Maintenance, Repair	15
Delivery, Transport, Disposal	15

Validity

The chapter “Safety” is valid as an instruction manual.

Specific processes and instructions in this instruction manual require special provisions to guarantee the safety of the operating personnel.

Used Symbols

This document contains information that you must read for your own personal safety and to avoid property damage. See [Important User Information on page 2](#) for information about different warning messages displayed depending on the risk level.

Target Group, Personnel

Responsibility for planning, assembly, commissioning, operation, maintenance, and dismounting lies with the plant operator.

Mounting, installation, commissioning, operation, maintenance, and disassembly of the device may only be carried out by appropriate trained and qualified personnel. The instruction manual must be read and understood.

Reference to Further Documentation

Observe laws, standards, and directives applicable to the intended use and the operating location. Observe Directive 1999/92/EC in relation to hazardous areas.

The corresponding technical data sheets, declarations of conformity, EC-type-examination certificates, certificates, and control drawings if applicable (see technical data sheet) are an integral part of this document. You can find this information under

<http://literature.rockwellautomation.com/>.

Due to constant revisions, documentation is subject to permanent change. Refer only to the most up-to-date version, which can be found under

<http://literature.rockwellautomation.com/>

Marking

Digital inputs

1719-IJ2, 1719-IBN8B

Analog inputs

1719-IR4B, 1719-IT4B

EC-Type Examination Certificate: PTB 03 ATEX 2042,
for additional certifications, see <http://www.rockwellautomation.com/products/certification/>

⊗ II (1) G [Ex ia] IIC

⊗ II (1) D [Ex ia] IIIC

Statement of conformity: PF 08 CERT 1234 X

⊗ II 3 G Ex nA IIC T4 Gc

Configurable modules

1719-CF4H

EC-Type Examination Certificate: BVS 11 ATEX E 116 X,
for additional certifications, see <http://www.rockwellautomation.com/products/certification/>.

⊗ II 3(1) G Ex nA [ia Ga] IIC T4 Gc

⊗ II (1) D [Ex ia Da] IIIC

Analog input

1719-IF4HB

EC-Type Examination Certificate: BVS 12 ATEX E 024 X,
for additional certifications, see <http://www.rockwellautomation.com/products/certification/>.

⊗ II 3(1) G Ex nA [ia Ga] IIC T4 Gc

⊗ II (1) D [Ex ia Da] IIIC

Backplane

1719-A22, 1719-A8, 1719-A24

EC-Type Examination Certificate: BVS 16 ATEX E 089 X
for additional certifications, see <http://www.rockwellautomation.com/products/certification/>.

⊗ II 3G Ex nA IIC T4

Digital output

1719-OB2, 1719-OB2L

Power Supply
1719-PSDC

Statement of conformity: PF 08 CERT 1234 X
 II 3 G Ex nA IIC T4 Gc

Communication Adapter
1719-AENTR

Type Examination Certificate: DEMKO 16 ATEX 1780X
 for additional certifications, see <http://www.rockwellautomation.com/products/certification/>.
 II 3 G Ex nA IIC T4 Gc

Intended Use

The device is only approved for appropriate and intended use. Ignoring these instructions will void any warranty and absolve the manufacturer from any liability.

The device must only be operated in the specified ambient temperature range and at the specified relative humidity without condensation.

The I/O modules of the distributed I/O system act as an interface between signals from the hazardous area and the non-hazardous area.

The I/O modules, adapters, and power supplies of the distributed I/O system must only be used together with the respective backplanes.

Observe the product information sheets for the respective backplanes.

Improper Use

Protection of the personnel and the plant is not ensured if the device is not being used according to its intended use.

Mounting and Installation

Prior to mounting, installation, and commissioning of the device you should make yourself familiar with the device and carefully read the product information sheets.

Do not mount the device at locations where an aggressive atmosphere may be present.

Do not mount a damaged or polluted device.

The device is designed for use in pollution degree 2 and overvoltage category II according to IEC/EN 60664-1.

If the device has already been operated in general electrical installations, the device may subsequently no longer be installed in electrical installations used in combination with hazardous areas.

If circuits with type of protection Ex i are operated with non-intrinsically safe circuits, they must no longer be used as circuits with type of protection Ex i.

Avoid electrostatic charges, which could result in electrostatic discharges while installing or operating the device.

Observe the installation instructions according to IEC/EN 60079-14.

Intrinsically safe circuits of associated apparatus (installed in non-hazardous area) can be led into hazardous areas. Observe the compliance of the separation distances to all nonintrinsically safe circuits according to IEC/EN 60079-14.

The respective peak values of the field device and the associated apparatus with regard to explosion protection should be considered when connecting intrinsically safe field devices with intrinsically safe circuits of associated apparatus (verification of intrinsic safety). Make sure to observe IEC/EN 60079-14 and IEC/EN 60079-25.

Do not push the I/O modules, adapters, and power supplies into the slots with too much force. The rear connections of the devices may be damaged if using excessive force. In this case, the explosion protection can no longer be ensured.

The backplane connections are non-intrinsically safe.

Connection or disconnection of energized non-intrinsically safe circuits is only permitted in the absence of a potentially explosive atmosphere.

The device must be disconnected from the power supply prior to installation and maintenance. The power supply may be activated only after all the circuits required for operation have been fully assembled and connected.

All non-intrinsically safe interfaces must only be connected to secure low protective voltages (SELV/PELV), the maximum root mean square (U_m) of which must not exceed 60V DC for the power supply connections and 30V AC/DC for the bus connection. The distributed I/O station must only be connected to the power supply voltages as specified on the type label.

Additional Requirements for Cables and Connection Lines

Observe the following points when installing cables and connection lines:

- Observe the permissible core cross-section of the conductor.
- The insulation stripping length must be considered.
- When installing the conductors the insulation must reach up to the terminal.
- If you use stranded conductor, crimp on wire end ferrules.
- Never pull the cable. A wire could become loose from the terminal and protection against electric shock can no longer be ensured. Always pull the terminal.

- Connectors for non-intrinsically safe circuits must be mechanically secured.
- The non-intrinsically safe cables have to be fixed with cable ties at the intended fixtures.
- Unused connection lines must be either connected to terminals or securely tied down and isolated.

Surrounding Enclosure

The device may only be installed and operated in Zone 2 or Class I, Div 2 if it has been mounted in a surrounding enclosure with degree of protection IP54 according to IEC/EN 60529. The surrounding enclosure must correspond to equipment protection level Gc.

The device may only be installed and operated in Zone 22 if mounted in a surrounding enclosure, which corresponds to equipment protection level Dc.

To ensure the degree of protection:

- All seals must be undamaged and correctly fitted.
- All screws of the surrounding enclosure/surrounding enclosure cover must be tightened with the appropriate torque.
- Only cable of the appropriate size must be used in the cable glands.
- All cable glands must be tightened with the appropriate torque.
- All unused cable glands must be sealed or plugged with corresponding stopping plugs.

Operation, Maintenance, Repair

Observe IEC/EN 60079-17 for maintenance and inspection.

When energized, the surrounding enclosure may only be opened for maintenance in Zone 2 or Class I, Div 2 if non-intrinsically safe circuit connections are protected by a cover with a degree of protection IP30.

If the seal on the enclosure cover or a seal on the cable gland is damaged, the seal must be replaced with a new seal provided by the manufacturer.

The device must not be repaired, changed, or manipulated.

If there is a defect, always replace the device with an original device from Rockwell Automation.

Delivery, Transport, Disposal

Check the packaging and contents for damage.

Check if you have received every item and if the items received are the ones you ordered.

Keep the original packaging. Always store and transport the device in the original packaging.

Store the device in a clean and dry environment. The permitted ambient conditions (see technical data sheet) must be considered.

Disposing of device, packaging, and possibly contained batteries must be in compliance with the applicable laws and guidelines of the respective country.



At the end of its life, this equipment should be collected separately from any unsorted municipal waste.

Product Specifications

Topic	Page
Introduction	18
1719 Ex I/O Components	19
Backplanes	20
Adapter	23
I/O Modules and Power Supplies	28
Accessories	33

Introduction

Distributed I/O stations are signal modification devices that act as an interface for signals between field devices and process control systems. The individual components, i.e., the I/O modules, adapters, and power supplies, are plugged into the slots on the backplane. The EtherNet/IP adapter, 1719-AENTR, forms the interface between the I/O modules and the process control system. Power supplies are used to power the I/O modules and adapters.

This manual sets out how to work with the hardware. For information on how to configure the adapter and I/O modules, refer to the Add-on Profile Help.

1719 Ex I/O Modules

Type	Catalog Number	Description
Communication Adapter	1719-AENTR	Ex I/O EtherNet/IP Adapter
Digital Input	1719-IJ	Ex I/O Frequency Counter
	1719-IBN8B	Ex I/O 8 Point Digital Input NAMUR Wide
Analog Input	1719-IF4HB	Ex I/O 4 Channel HART Analog Input Wide
	1719-IR4B	Ex I/O 4 Channel RTD Input
	1719-IT4B	Ex I/O 4 Channel Thermocouple Input
Configurable Analog Input/Output	1719-CF4H	Ex I/O 4 Channel HART Analog Configurable
Digital Output	1719-OB2	Ex I/O 2 Point Digital Output 23V
	1719-OB2L	Ex I/O 2 Point Digital Output 16.5V
Power Supply	1719-PSDC	Ex I/O DC Power Supply
Backplane	1719-A22	Ex I/O 22 Slot Base Chassis
	1719-A8	Ex I/O 8 Slot Base Chassis
	1719-A24	Ex I/O 24 Slot Extension Chassis
Terminal Blocks	1719-TB6	Ex I/O 6 Pole Screw Terminal
	1719-TB6S	Ex I/O 6 Pole Spring Terminal
	1719-TB8	Ex I/O 8 Pole Screw Terminal
	1719-TB8S	Ex I/O 8 Pole Spring Terminal
	1719-TB8x2	Ex I/O 2x8 Pole Screw Terminal
	1719-TB8Sx2	Ex I/O 2x8 Pole Spring Terminal
Connection Cable	1719-CBL	Ex I/O Chassis Extension Cable 1 m
Placeholder	1719-ARM	Ex I/O Empty Slot Cover

1719 Ex I/O Components

1719 Ex I/O Components Overview

See the following graphic and table for a description of 1719 Ex I/O components:

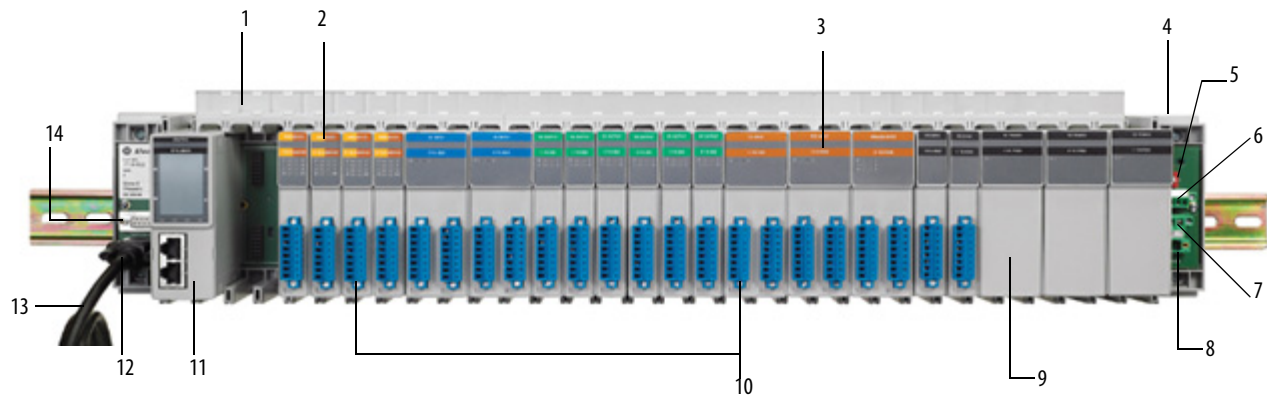

	Description		Description
1	Label carrier	8	24V power supply
2	I/O module (single-width)	9	Power supply module
3	I/O module (dual-width)	10	Field connections
4	Backplane (1719-A22)	11	Adapter (1719-AENTR)
5	Function switch	12	Extension connection
6	Bus-independent deactivation of the I/O modules	13	Extension cable
7	Redundant 24V power supply	14	Service interface

Properties of Individual Components

Function	Zone 2 or Class I, Div 2					Shutdown Input
	Ex nA	Ex nA nC	Ex ic	Ex ib	Ex ia	
Digital input for frequency, counters, direction, 1-channel					1719-IJ	
Digital input, 8-channel					1719-IBN8B	
HART transmitter power supply, input isolator, 4-channel					1719-IF4HB	
RTD converter, 4 channel					1719-IR4B	
Thermocouple converter, 4 channel					1719-IT4B	
Configurable input/output (HART), 4 channel					1719-CF4H	
Power supply, 24V DC	1719-PSDC					
Redundant base backplane, 22 slots	1719-A22					X
Base backplane, 8 slots	1719-A8					X
Extension backplane, 24 slots	1719-A24					X
EtherNet/IP adapter	1719-AENTR					

Backplanes

Function

Backplanes are used to hold adapters, power supplies, and I/O modules. Fixed slots are reserved on the backplane for adapters and power supplies. Slots for I/O modules have equal status, meaning functions can be arranged side by side as required.

Design and Dimensions

1719-A22

- Base backplane with slots for redundant adapters
- Slots for max. 22 single-width or 11 dual-width I/O modules

Dimensions of 1719-A22

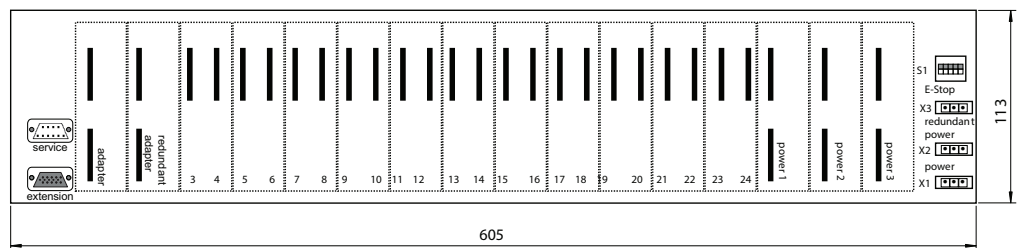

1719-A8

- Base backplane
- Slots for max. 8 single-width or 4 dual-width I/O modules

Dimensions of 1719-A8

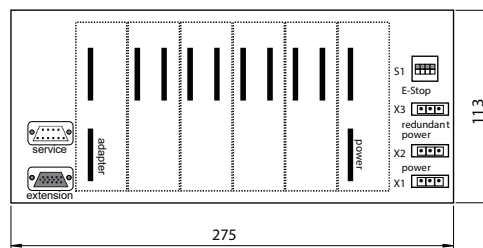

1719-A24

- Extension backplane
- Slots for max. 24 single-width or 12 dual-width I/O modules

Dimensions of 1719-A24

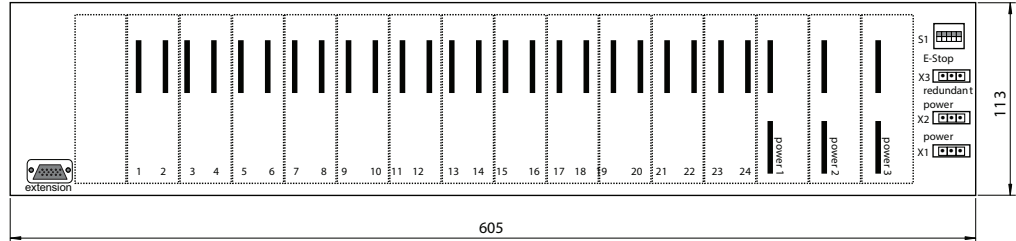

Side View

Side View of a Populated Backplane

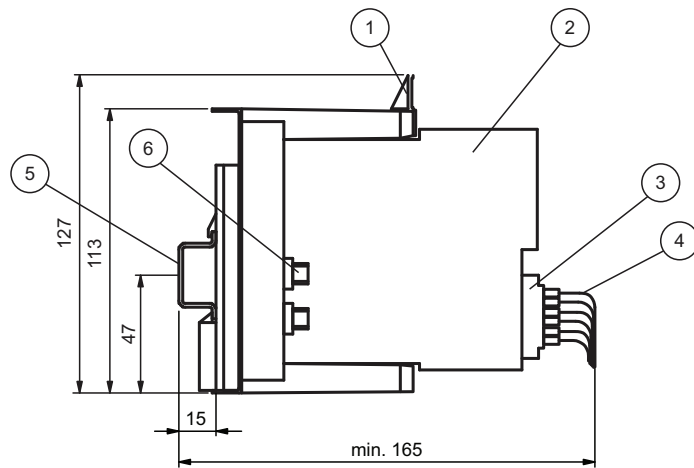

Table 1 - Side View of a Populated Backplane Parts

Description		Description	
1	Label carrier	4	Field cable
2	I/O module	5	NS 35/15 DIN mounting rail
3	Front connector	6	Fieldbus connection

Backplane Combinations

Base backplanes can be extended using an extension backplane. The I/O modules on the extension backplane are controlled via the adapters on the base backplane. The power supply for the additional I/O modules is provided by additional power supplies on the extension backplane.

Base Backplane	Extension Backplane
1719-A22	1719-A24
1719-A8	1719-A24

When working with an extension backplane, take note of the following:

- Online addition of an extension backplane while the system is in Run mode is not supported.
- Make sure that the program configuration matches the hardware setup. Studio 5000® does not know how many slots are in the base backplane or extension backplane. Only the total number of slots is checked. Therefore, Studio 5000 allows you to add dual-width modules across a backplane boundary. In this case, the project can be downloaded to the controller but the controller will not establish a connection.
- Each module requires at least one EtherNet/IP connection. Additionally, the I/O modules support listen-only connections.

Backplane and Module Compatibility

In principle, 1719 backplanes are compatible with all 1719 modules. Single-width I/O modules occupy one slot, while dual-width I/O modules occupy two slots. However, be aware of the following restrictions.

Temporary Overload of the Power Supply

To avoid a temporary overload of the power supply in the startup phase, the number of certain I/O modules on the chassis is limited.

Use a maximum of eight 1719-IF4HB four-channel I/O modules per chassis. Each I/O module consumes 12.5% of the startup capacity.

Scope of Delivery

Base backplanes are not delivered with any accessories. Extension backplanes are delivered with a 1-m-long double-ended cordset (1719-CBL). The double-ended cordset establishes the connection to the base backplane.

Adapter

Function

The Ex I/O platform connects to the control system via EtherNet/IP through the 1719-AENTR adapter.

An adapter can control up to 46 I/O modules and transfer their signals across EtherNet/IP. The adapter converts the protocol of the bus that is integrated in the backplane to the protocol of EtherNet/IP.

IMPORTANT The total power consumption of the selected modules on each rack must not exceed the maximum power that is supplied by the selected power supply module configuration.

The 1719-AENTR offers native Device Level Ring (DLR) support and includes two RJ45 Ethernet interfaces.

Adapter Components

See the following figure to identify the components of the 1719-AENTR adapter.

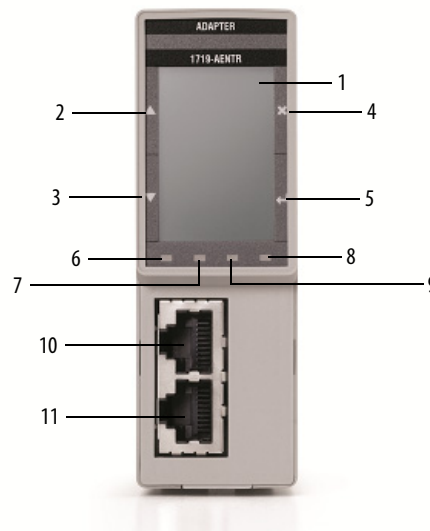

	Description		Description
1	LCD screen	7	NET LED (Network Status)
2	Up navigation	8	LINK1 LED (Link Status Port 1)
3	Down navigation	9	LINK2 LED (Link Status Port 2)
4	Cancel/Back	10	Ethernet Port 1
5	Enter/OK	11	Ethernet Port 2
6	OK LED (Adapter Status)		

Adapter Considerations



ATTENTION: To prevent damage to the 1719-AENTR adapter, connect all Ethernet cables before the adapter is powered on and avoid disconnecting Ethernet cables while the adapter is online.

Determine Compatibility

The 1719-AENTR Add-on Profile must be used with one of the following:

- Studio 5000, version 24 or later
- RSLinx®, version 3.74 or later

Add-on Profile Considerations

- The adapter can be configured using the Add-on Profile. For more information, see the Add-on Profile help.
- In the Add-on Profile display, on the Module Info page, the Internal State of the adapter shows Run mode regardless of the status of the controller (Program mode or Run mode).
- Modules can only be reset by inhibiting the module through the Add-on Profile.
- The 1719-AENTR adapter does not support half-duplex (or 1 Gbps speed) on the Ethernet ports.

EtherNet/IP Network

EtherNet/IP is a network suitable for use in industrial environment and time-critical applications. EtherNet/IP uses standard Ethernet and TCP/IP and UDP technologies and an open application layer protocol that is called the Common Industrial Protocol (CIP). The 1719-AENTR connects Ex I/O to EtherNet/IP enabled controllers such as ControlLogix® or CompactLogix™.

To connect EtherNet/IP in Zone 2 or Class I, Div 2 areas, reference the appropriate wiring standards for hazardous areas:

- For Class I, Div.2 follow NEC 500-510
- For Zone 2, follow IEC 60079-14

Use the Module on a Device Level Ring Network

A Device Level Ring (DLR) network is a single-fault-tolerant ring network that is intended for the interconnection of automation devices without the need for additional switches. The ring topology offers these advantages:

- Media redundancy
- Fast network fault detection and reconfiguration
- Resiliency of a single-fault tolerant network

- Easy implementation without any additional hardware requirements

One DLR network can support as many as 50 nodes. A DLR network supports copper connections (maximum of 100 m [328 ft]), fiber-optic connections (maximum of 2 km [1.24 mi]), or a mix of copper and fiber.

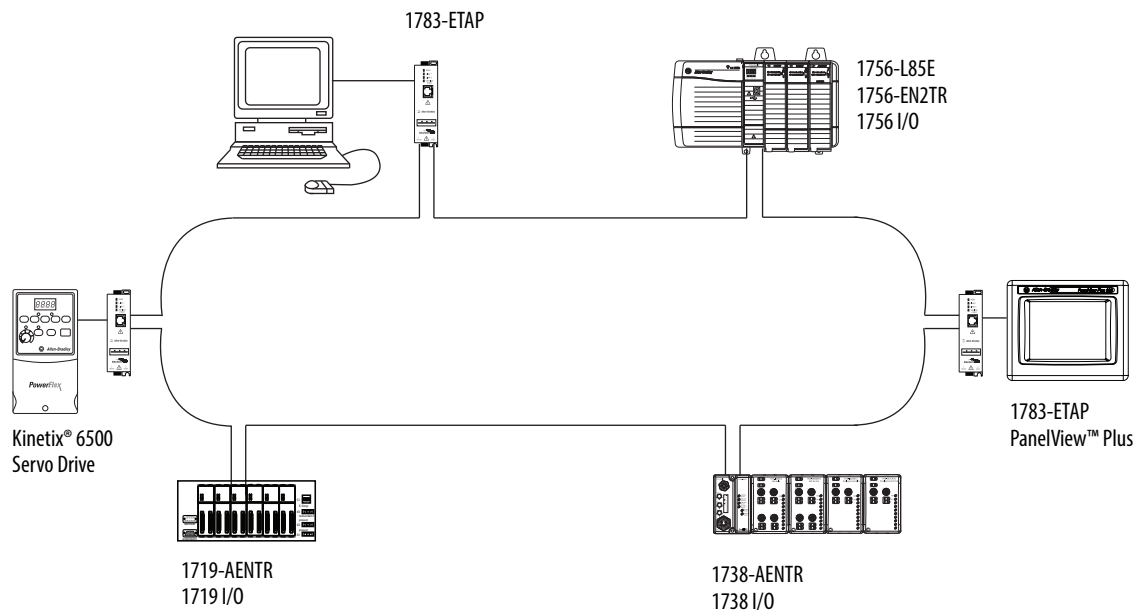

For more information about EtherNet/IP, refer to EtherNet/IP Embedded Switch Technology Application Guide, publication [ENET-AP005](#).

1719-AENTR LCD Screen

The 1719-AENTR offers an LCD screen with several menus displaying system information.

On any screen, the Up/Down navigation arrows allow the user to scroll through the list of information or options, Enter/OK(↵) selects a chosen option, and Cancel/Back (X) returns the user to the previous screen.

Note that the LCD is a 4 quadrant touch screen. Pressing in the upper left quadrant selects the Up navigation, pressing the lower left quadrant selects the Down navigation, pressing the upper right quadrant selects Cancel/Back, and pressing the lower right quadrant selects Enter/OK. To prevent damage to the LCD screen, do not use a sharp or pointed object to navigate the menus.

Start Screen

The Start screen displays the device status including any channels with error messages and any devices plugged into the backplane but not configured.

Additionally, the Start screen displays the current IP address and firmware revision.

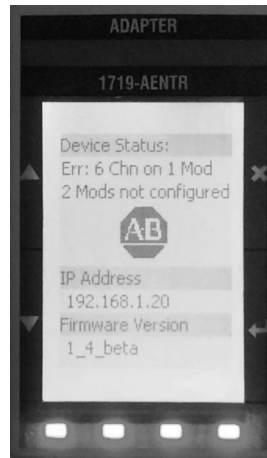

Main Menu

The Main Menu offers the option to select from the following screens: Diagnostic, Parameter, or Service.



- Diagnostic** - The Diagnostic screen allows you to view diagnostic information for a given module. On the left side of the screen, the user will see a list of channels. The top of the screen displays the selected device type and slot.

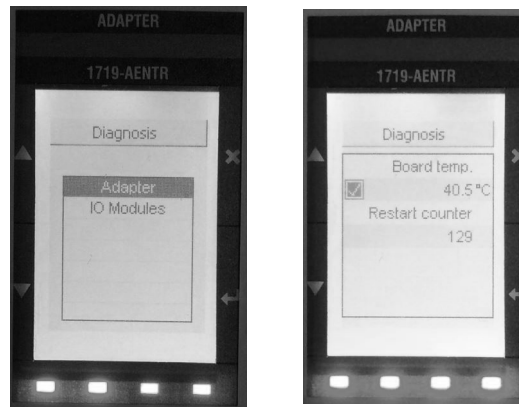

For analog modules, the screen displays the current channel that is selected, value in engineering units, channel status (indicates "OK", indicates "ERROR") and a text message for diagnostic information.



For digital modules, the screen displays diagnostic information in tabular form where the column labeled "C" indicates the channel number, "V" indicates the current value, "S" indicates channel status (indicates "OK", indicates "ERROR"), And "Message" Indicates the text message for diagnostic information.



- **Parameter** - The Parameter screen allows the user to view and select EtherNet/IP parameters including DHCP (On/Off), IP address, Subnet Mask, and Default Gateway.

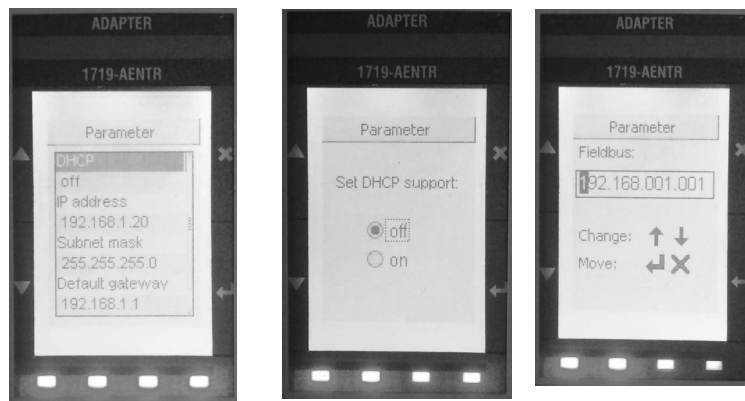

- **Service** - The Service screen displays basic system information including software version, Uboot version, Preloader version, Sysid time stamp, current date/time, and Uptime (shown as the time elapsed since previous boot).

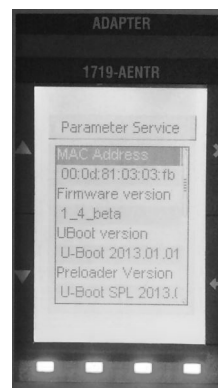

I/O Modules and Power Supplies

Function

I/O modules are signal modification devices. Field signals from a hazardous area are prepared for controllers or process control systems in a safe area. The slots for the I/O modules on the backplane have equal status, meaning functions can be arranged side by side as required.

Adapters form the interface between the I/O modules and the process control system. An adapter can control up to 45 I/O modules and transfer their signals across EtherNet/IP. The adapter converts the protocol of the bus that is integrated in the backplane to the protocol of EtherNet/IP. For more information, see [Adapter on page 23](#).

Power supplies provide power to the I/O modules and the associated adapters on a backplane. The slots for power supplies and adapters are mechanically coded on the backplane and marked with a label.

Design and Dimensions

Both single-width and dual-width modules are available. Adapters and power supplies are always dual-width. I/O modules are single-width or dual-width depending on the model.

Single-width modules occupy one I/O slot on the chassis. Dual-width models are identified with a B at the end of the catalog string and occupy two I/O slots on the chassis.

Both the I/O modules and the adapters and power supplies are equipped with LEDs on the front that display the device status.

The I/O modules have connections on the front to which the relevant field devices are connected.

Single-width I/O Module Dimensions

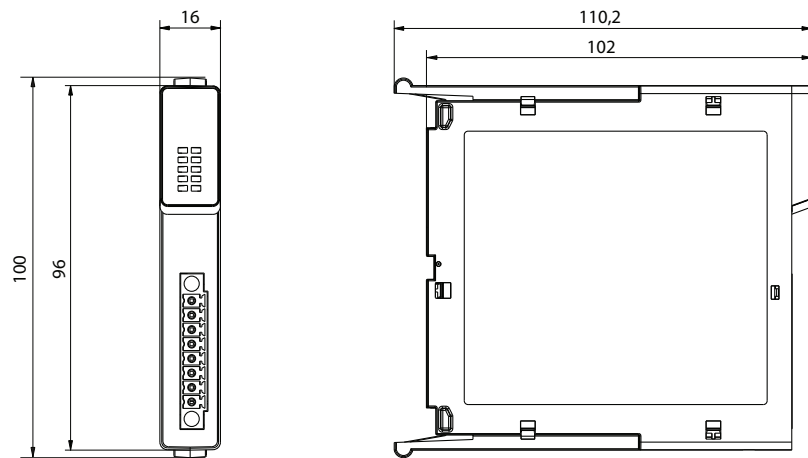

Dual-width I/O Module Dimensions

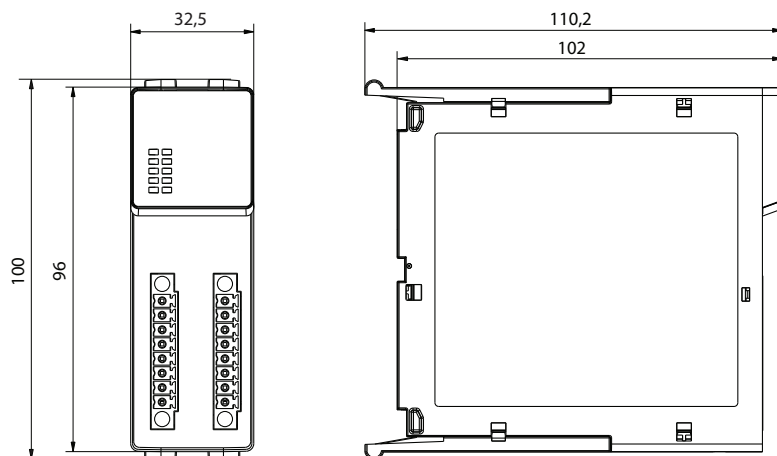

Analog Module Selection Guide

- **1719-CF4H**
 The 1719-CF4H is a configurable input/output module. The module can be configured as either analog input or analog output. As an analog input device, it feeds 2-wire transmitters. As an analog output device, it can drive proportional valves, I/P converters, or local indicators. Note that the module is not configurable by channel. The 1719-CF4H offers 12-bit resolution.
- **1719-IF4HB**
 The 1719-IF4HB is an analog input module that feeds 2- and 3-wire transmitters. Active signals from separately powered field devices and 4-wire transmitters can also be connected. The 1719-IF4HB offers 12-bit resolution.
- **1719-IR4B**
 The 1719-IR4B is an RTD converter that accepts 2-, 3-, 4-wire RTD signals and slide-wire sensors from the field. The 1719-IR4HB offers 12-bit resolution.
- **1719-IT4B**
 The 1719-IT4B is a thermocouple converter that accepts thermocouple or mV signals from the hazardous area and offers 12-bit resolution. The 1719-IT4B I/O module is equipped with an internal cold junction. However, it can be used with an external cold junction. Using the Add-on Profile, you can set the cold junction compensation mode to either Local (internal) or Remote (external).
 For more information, see the Add-on Profile help topic for the 1719-IT4B module.

A note on Analog Module Resolution:

When configuring the module with the Add-on Profile, the user can select the sensor type and expected measuring range. Selecting the appropriate measuring range configures the module to deliver the best resolution for the range selected. For more information, see the Add-on Profile help topic for the 1719 analog modules.

Digital Output Module Selection Guide

There are two digital output modules available to support different power requirements of connected devices: 1719-OB2 and 1719-OB2L.

The digital output modules can be configured to use the two channels separately and independently or to combine the two outputs to one logical output with more power. When the module is operating in the latter configuration, referred to as "2 in 1 Mode," the LED labeled "M" on the front of the 1719-OB2 or 1719-OB2L will be illuminated. In the Add-on Profile, the two modes are referred to as "Low Current, Two Points," and, "High Current, One Point."

When the module is used with two separate channels, the 1719_DO2_Diag:C:0 configuration assembly should be used for the configuration data. In this case, the 1719_DO2:O:0 has to be used as output assembly and the 1719_DO2_Diag:I:0 has to be used as input assembly for read back and status information.

When the module is used in 2 in 1 mode, with the two outputs combined to one logical channel, the 1719_DO1_Diag:C:0 configuration assembly should be used for the configuration data. In this case, the 1719_DO1:O:0 has to be used as output assembly and the 1719_DO1_Diag:I:0 has to be used as input assembly for read back and status information.

The following table lists the compatible solenoids for the 1719-OB2 and 1719-OB2L digital output modules:

Manufacturer	Solenoid	1719-OB2	1719-OB2 2in1	1719-OB2L	1719-OB2L 2in1
ASCO	IS-M12-I	0 ... > 300 Ohm	0 ... > 300 Ohm	0 ... 275 Ohm	0 ... > 300 Ohm
ASCO	Series 195	0 ... 120 Ohm			
ASCO	Series 302 (LP1 "12V" 0.5 W)	0 ... 67 Ohm	0 ... 196 Ohm		
ASCO	Series 302 (LP1 "24V" 0.25 W)	0 ... 194 Ohm	0 ... > 300 Ohm		
ASCO	Series 302 (LP1 "24V" 0.5 W)		0 ... 84 Ohm		
ASCO	Series 622 (Spool Valve Island)	0 ... 194 Ohm	0 ... > 300 Ohm		
ASCO	Series 630: Piezotronic 12V (12 mW Version)	0 ... > 300 Ohm		0 ... > 300 Ohm	
ASCO	Series 630: Piezotronic 12V (32 mW Version)	0 ... 212 Ohm		0 ... > 300 Ohm	
ASCO	Series 630: Piezotronic 6V (3 mW Version)	0 ... > 300 Ohm		0 ... > 300 Ohm	
ASCO	Series 630: Piezotronic 8V (22 mW Version)	0 ... 42 Ohm		0 ... 169 Ohm	
ASCO	Series LI WSLI	0 ... 70 Ohm	0 ... 199 Ohm		0 ... 59 Ohm
ASCO	Series LISC	0 ... 25 Ohm	0 ... 154 Ohm		
ASCO	Series NFIS WSNFIS	0 ... > 300 Ohm	0 ... > 300 Ohm	0 ... 299 Ohm	0 ... > 300 Ohm
ASCO	Series WPIS WSJS	0 ... > 300 Ohm	0 ... > 300 Ohm	0 ... > 300 Ohm	0 ... > 300 Ohm
ATOS	OW-18/H		0 ... 51 Ohm		0 ... 14 Ohm
BC	BC-x.8.12.25			0 ... 28 Ohm	0 ... 93 Ohm
BC	BC-x.8.12.30				0 ... 67 Ohm
BC	BC-x.8.12.35				0 ... 48 Ohm
BC	BC-x.8.12.40				0 ... 34 Ohm
BC	BC-x.8.12.45				0 ... 23 Ohm
BC	BC-x.8.12.50				0 ... 14 Ohm
Buerkert	Coil AC 10 EEXi für Ventile:0590EEXi, 6014EEXi, 6518EEXi, 6519EEXi	0 ... 149 Ohm			
Buerkert	Coil AC21 EEXi für Ventile:0450EEXi, 5470EEXi, 6106EEXi, 6516EEXi, 6517EEXi	0 ... 175 Ohm			
Buerkert	Coil G1 642735 EEXi;6104 EEXi, 6510 EEXi, 6511 EEXi, 6524 EEXi,6525EEXi, 8631EEXi	0 ... 164 Ohm		0 ... 67 Ohm	
FAS	Microsol_12V_T4_85		0 ... 108 Ohm		0 ... 12 Ohm
FAS	Microsol_12V_T5_50		0 ... 108 Ohm		0 ... 12 Ohm
Festo	CPV10-EX-VI	0 ... 116 Ohm			
Festo	MFVH* (Coil: GBXE 022*)		0 ... 206 Ohm	0 ... 53 Ohm	0 ... 118 Ohm
Herion	2010...2014				0 ... 74 Ohm
Herion	2050	0 ... 197 Ohm	0 ... 300 Ohm	0 ... 127 Ohm	0 ... 192 Ohm
Herion	2051	0 ... 230 Ohm	0 ... 300 Ohm	0 ... 86 Ohm	0 ... 152 Ohm

Manufacturer	Solenoid	1719-OB2	1719-OB2 2in1	1719-OB2L	1719-OB2L 2in1
Herion	2052	0 ... 213 Ohm	0 ... 300 Ohm		0 ... 22 Ohm
Herion	2053	0 ... 50 Ohm	0 ... 179 Ohm		
Herion	2080/2082	0 ... 300 Ohm		0 ... 300 Ohm	
Herion	2081/2082	0 ... 300 Ohm		0 ... 300 Ohm	
Herion	2084	0 ... 300 Ohm		0 ... 300 Ohm	
Hoerbiger	PN61	0 ... 300 Ohm	0 ... 300 Ohm	0 ... 300 Ohm	0 ... 300 Ohm
Hoerbiger	PN65	0 ... 300 Ohm	0 ... 300 Ohm	0 ... 300 Ohm	0 ... 300 Ohm
Honeywell-Lucifer	Coil mit 295 Ohm	0 ... 121 Ohm			
KVAutomation	KVEX131	0 ... 113 Ohm	0 ... 242 Ohm	0 ... 55 Ohm	0 ... 120 Ohm
Norgren	2003	0 ... 242 Ohm			
Norgren	Coil 06129(2086)	0 ... > 300 Ohm			
Parker	488650.01/03_488660.01/03_488670.01/03	0 ... 139 Ohm			
Parker	492965.01/02	0 ... 242 Ohm			
Parker	495910	0 ... 186 Ohm			
Parker	495910N7	0 ... 177 Ohm			
RGS	Coil EP100/ia	0 ... 91 Ohm	0 ... 220 Ohm	0 ... 15 Ohm	0 ... 80 Ohm
Samson	3701-11	0 ... > 300 Ohm			
Samson	3701-12	0 ... > 300 Ohm			
Samson	3701-13	0 ... > 300 Ohm			
Samson	3775-13	0 ... > 300 Ohm			
Samson	3962-13	0 ... > 300 Ohm			
Samson	3962-17	0 ... > 300 Ohm			
Samson	3963-12	0 ... > 300 Ohm			
Samson	3963-13	0 ... > 300 Ohm			
Samson	3963-17	0 ... > 300 Ohm			
Samson	3967-1	0 ... > 300 Ohm			
Samson	3967-2	0 ... > 300 Ohm			
Samson	3967-3	0 ... > 300 Ohm			
Seitz	PV 12F73 Ci oh	0 ... > 300 Ohm		0 ... > 300 Ohm	
Seitz	PV 12F73 Xi oh	0 ... > 300 Ohm		0 ... > 300 Ohm	
Seitz	PV 12F73 Xi oh 2	0 ... > 300 Ohm		0 ... > 300 Ohm	
Seitz	Typ 11G52 Art.-Nr.121 113 01	0 ... 242 Ohm			
SMC	52-SY5000	0 ... 63 Ohm		0 ... 19 Ohm	
SMC	52-SY7000	0 ... 63 Ohm		0 ... 19 Ohm	
SMC	52-SY9000	0 ... 63 Ohm		0 ... 19 Ohm	
Telektron	Coil L (12 ... 24 V)	0 ... > 300 Ohm			
Wandfluh	ISI 4401-03				0 ... 17 Ohm

Power Supplies

One power supply module can provide up to 30 W if the chassis is mounted in a Zone 2/Class I, Div 2 area and up to 45 W if the chassis is mounted in a safe area. Note that the power dissipation is approximately 15% of the power consumption.

Based on the module configuration, additional power supply modules may be added to the 1719-A22 and 1719-A24 chassis to support the power consumption requirements of all the modules on the chassis. When more than one power supply module is used, the load is automatically shared between the power supply modules. Up to three power supply modules can be used on the 1719-A22 or 1719-A24, offering N+1 power supply redundancy.

The Integrated Architecture® Builder includes a power consumption calculator to support determining how many power supply modules are required. The table below shows the consumption values of each module at 12V DC:

Catalog	Catalog Description	Power Consumption (W)	Power Dissipation (W)
1719-AENTR	Ex I/O EtherNet/IP Adapter	3.00	3.00
1719-CF4H	Ex I/O 4 Channel HART Analog Configurable	3.00	2.00
1719-IF4HB	Ex I/O 4 Channel HART Analog Input Wide	3.00	2.00
1719-IR4B	Ex I/O 4 Channel RTD Input	0.40	0.40
1719-IT4B	Ex I/O 4 Channel Thermocouple Input	0.70	0.70
1719-IBN8B	Ex I/O 8 Point Digital Input NAMUR Wide	1.00	1.00
1719-OB2	Ex I/O 2 Point Digital Output 23V	3.00	2.00
1719-OB2L	Ex I/O 2 Point Digital Output 16.5V	3.00	2.00
1719-IJ	Ex I/O Frequency Counter	0.70	0.70
1719-PSDC	Ex I/O DC Power Supply	Depends on Module Load	15% of Power Consumption

Accessories

Field Wiring

The following accessories are available for field wiring.

Terminal Blocks

Terminal blocks are wired to the field devices, attached to the front sockets of the I/O modules, and tightened using the side screws. Terminal blocks can come in the form of screw terminals or spring terminals.

- Screw terminals
 - Blue: 1719-TB6, 1719-TB8, 1719-TB8x2
- Spring terminals
 - Blue: 1719-TB6S, 1719-TB8S, 1719-TB8Sx2

Screw terminals

Screw Terminal Dimensions

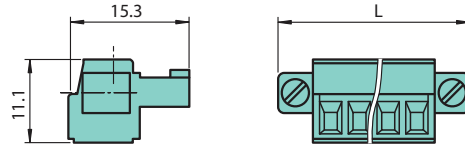

L = 33.3 mm for 6-pin terminal and 40.9 mm for 8-pin terminal

Spring terminals

Spring Terminal Dimensions

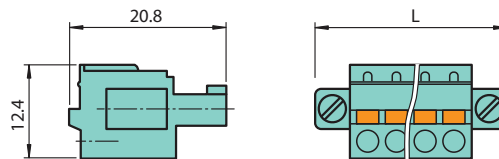

L = 33.3 mm for 6-pin terminal and 40.9 mm for 8-pin terminal

Spring Terminals for Single-Width I/O Modules with 2x8 Connections

Spring Terminal Dimensions

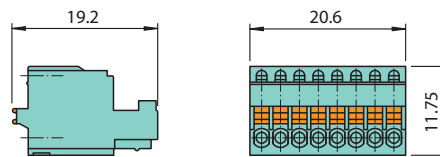

To determine which terminal is compatible with each module, refer to the following table:

Catalog	Catalog Description	Compatible Spring Terminal	Compatible Screw Terminal
1719-CF4H	Ex I/O 4 Channel HART Analog Configurable	1719-TB8S	1719-TB8
1719-IF4HB	Ex I/O 4 Channel HART Analog Input Wide	1719-TB8Sx2	1719-TB8x2
1719-IR4B	Ex I/O 4 Channel RTD Input	1719-TB8Sx2	1719-TB8x2

Catalog	Catalog Description	Compatible Spring Terminal	Compatible Screw Terminal
1719-IT4B	Ex I/O 4 Channel Thermocouple Input	1719-TB8Sx2	1719-TB8x2
1719-IBN8B	Ex I/O 8 Point Digital Input NAMUR Wide	1719-TB8Sx2	1719-TB8x2
1719-OB2	Ex I/O 2 Point Digital Output 23V	1719-TB8S	1719-TB8
1719-OB2L	Ex I/O 2 Point Digital Output 16.5V	1719-TB8S	1719-TB8
1719-IJ	Ex I/O Frequency Counter	1719-TB6S	1719-TB6
1719-ARM	Ex I/O Empty Slot Cover	1719-TB8S	1719-TB8

Coding Pins

Coding pins provide a unique assignment between I/O modules and terminal blocks or the associated field devices. To do this, the coding pins are pushed into the grooves that are provided in the front sockets of the I/O modules. This prevents terminal blocks from being accidentally plugged into another I/O module.

- Coding pins
 - 1719-CP for 1719-TB6, 1719-TB6S, 1719-TB8, 1719-TB8S 1719-TB8x2, 1719-TB8Sx2

1719-CP coding pins

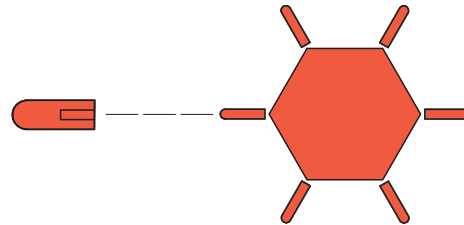

For more information and examples of how to use the 1719-CP coding pins, refer to the 1719 Ex I/O Installation Instructions, publication [1719-IN001](#).

Notes:

Commissioning

Topic	Page
Electrical Testing of Connections	37
Configuration	37
Startup Phase	38

Electrical Testing of Connections

Make sure that the plugs have been properly fitted to the EtherNet/IP RJ45 ports.

For more information, see EtherNet/IP Connection section of the 1719 Ex I/O Installation Instructions, publication [1719-IN001](#).

Testing and Addressing the EtherNet/IP Connection



WARNING: Risk of explosion

When taking measurements in hazardous areas, there is a risk of explosion from sparks forming.

Take measurements on the terminal connections of a distributed I/O station, with a hot work permit only, in other words when there is no potentially explosive atmosphere.

For information about testing and addressing of EtherNet/IP modules, refer to the EtherNet/IP Adapter User Manual, publication [ENET-UM001](#).

If you have not installed the Rockwell Software® BOOTP-DHCP Server for setting the network IP address, you can download and install it from: <http://www.software.rockwell.com/download/comms/rsnetworx/bootp-dhcp%20server%20.3.2.zip>.

Configuration

The entire distributed I/O station is configured in the Add-on Profile:

1. Add a network card to the project (if needed).
2. Add a 1719 adapter to the project. Enable the status connection if diagnostics are needed.

3. Add I/O modules on the 1719 bus.
4. Set the configuration as needed (on the Points tab for digital modules and the Channels tab for analog modules).

For more information, see the Add-on Profile Help.

Startup Phase

Do not start to operate all the distributed I/O stations simultaneously; instead, connect each distributed I/O station to the master in succession.

Temporary Overload of the Power Supply

To avoid a temporary overload of the power supply in the startup phase, the number of certain I/O modules on the chassis is limited.

Use a maximum of eight 1719-IF4HB four-channel I/O modules per chassis. Each I/O module consumes 12.5% of the startup capacity.

Operation



WARNING: Risk of explosion

If I/O modules are hot swapped, there is a risk of explosion due to sparks forming, since the connections on the backplane are not intrinsically safe.

Before replacing I/O modules, make sure that the atmosphere is not potentially explosive, for example, by obtaining a hot work permit.

During operation, you can access up-to-date measured values and diagnostic information for the I/O modules through the adapter. For more information, see the help topic for the adapter.

In addition, you can read off basic information about supply and communication from the LEDs on the I/O modules and adapters. For more information about the LEDs, refer to the technical data sheets for the I/O modules and the adapter.

Ownership

Every I/O module in a Logix control system must be owned by a controller, also known as the owner-controller. When the 1719 Ex I/O modules are used in a Logix control system, the owner-controller performs the following:

- Stores configuration data for every module that it owns.
- Can reside in a location that differs from the 1719 Ex I/O.
- Sends the I/O module configuration data to define module behavior and begin operation in the control system.

Each 1719 Ex I/O module must continuously maintain communication with its owner-controller during normal operation. The 1719 Ex I/O modules are limited to one owner-controller that performs the functions that are listed previously. Other controllers can establish Listen-Only connections to the 1719 Ex I/O modules. If a controller uses a Listen-Only connection, the connection must use the Multicast option.

Configure a 1719 Ex I/O System

You must create a Studio 5000 Logix Designer® application project for the Logix controller that owns the 1719 Ex I/O module. The project includes module configuration data for the 1719 Ex I/O modules. The Logix Designer application transfers the project to the owner-controller during the program download. Data is then transferred to the 1719 Ex I/O modules over the

EtherNet/IP network. The 1719 Ex I/O modules can operate immediately after receiving the configuration data.

Connections

During module configuration, you must define the module. Among the Module Definition parameters, you must choose a connection type for the module. A connection is a real-time data transfer link between the owner-controller and the module that occupies the slot that the configuration references.

When you download module configuration to a controller, the controller attempts to establish a connection to each module in the configuration.

For information on individual module configuration, refer to the Add-on Profile help file.

Addressing with 1719 Ex I/O

When manually configuring 1719 Ex I/O, it is important to note the slot numbering sequence.

In general, the following rules must be considered:

- The I/O modules can be placed in any sequence on the chassis. Single-width and dual-width modules can be mixed in any sequence on the chassis as well.
- A single-width module occupies one slot on the chassis.
- A dual-width module occupies two slots on the chassis, which is consistent with what is displayed in the Studio 5000 or RSLinx I/O tree.
- There can be empty slots on the chassis. When an empty slot exists, the slot maintains its address but is left vacant. If a slot is left empty or if a 1719-ARM placeholder is mounted, the slot does not appear in the I/O tree (and is available for a module to be mounted to this slot at a later time, if required).
- When using the 1719-A24 extension chassis, the first available I/O module slot on the extension chassis is addressed as the next available slot in the I/O tree, that is, Slot 9 if connected to a 1719-A8 chassis or Slot 23 if connected to a 1719-A22 chassis.

For your reference, an example chassis is provided below followed by the corresponding Studio 5000 and RSLinx I/O tree.

In the example, a 1719-A22 chassis is used with a 1719-AENTR adapter in Slot 0. A mix of single and dual-width I/O modules are shown in addition to leaving empty slots and using 1719-ARM placeholders.

Example Module Configuration

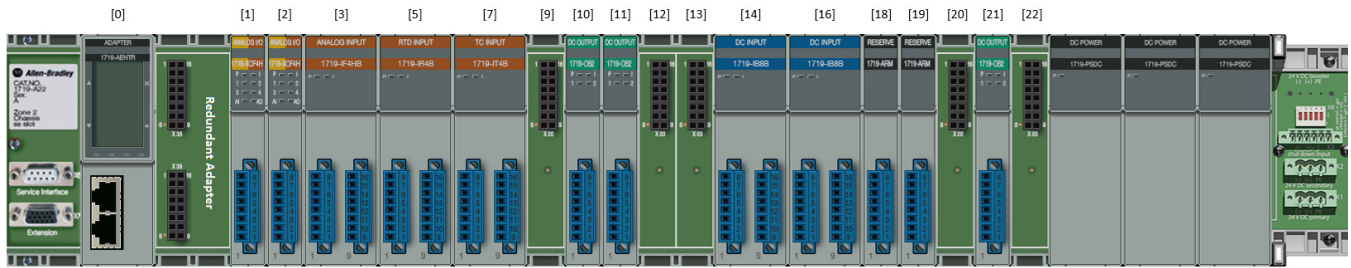

Corresponding Studio 5000 I/O Tree

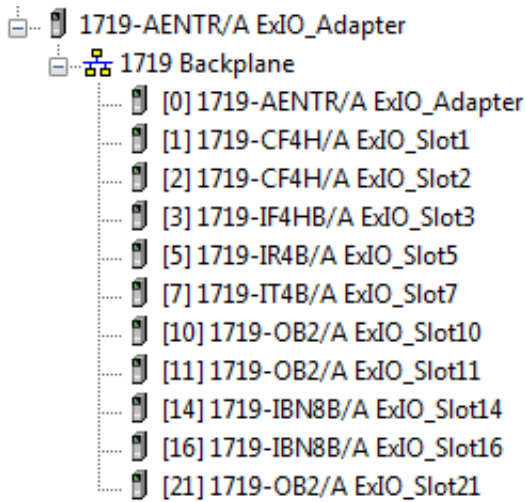

Corresponding RSLinx I/O Tree

Address	Device Type
00	1719-AENTR Ex I/O EtherNet/IP Adapter
01	1719-CF4H Ex I/O 4 Channel HART Analog Configurable
02	1719-CF4H Ex I/O 4 Channel HART Analog Configurable
03	1719-IF4HB Ex I/O 4 Channel HART Analog Input Wide
05	1719-IR4B Ex I/O 4 Channel RTD Input
07	1719-IT4B Ex I/O 4 Channel Thermocouple Input
10	1719-OB2 Ex I/O 2 Point Digital Output 23V
11	1719-OB2 Ex I/O 2 Point Digital Output 23V
14	1719-IBN8B Ex I/O 8 Point Digital Input NAMUR Wide
16	1719-IBN8B Ex I/O 8 Point Digital Input NAMUR Wide
21	1719-OB2 Ex I/O 2 Point Digital Output 23V

Notes:

1719 Ex I/O HART Analog I/O Modules

Topic	Page
HART Communication	44
Asset Management Software	45
HART Device Info Tab	46
HART Command Tab - 1719-IF4HB, 1719-CF4H	50
Data in the Input Tags	50
Getting HART Data by Using CIP MSG	56
HART Modules Used with Asset Management Software	56

1719 Ex I/O HART analog I/O modules connect a Logix controller to your process. HART input modules (1719-IF4HB, 1719-CF4H⁽¹⁾) receive signals from process value transmitters and convert them to corresponding measurement values for use in the Logix controller (for example, temperature, flow, pressure, or pH). HART output modules (1719-CF4H⁽¹⁾) provide current or voltage output signals that adjust the settings of valves and other devices in accord with desired process behavior.

Instruments that support the HART protocol allow several process parameters to be measured with one field device, provide status and diagnostics information, and allow remote configuration and troubleshooting.

(1) The 1719-CF4H module can be configured either as an analog input or analog output module.

HART Communication

The HART field communication protocol is widely accepted in industry as a standard for digitally enhanced 4...20 mA communication with smart (microprocessor-based) field devices. A digital signal is superimposed on the 4...20 mA current loop to provide two means of communication from the device. The 4...20 mA analog channel lets the primary process variable be communicated at the fastest possible rate while the digital channel communicates multiple process variables, data quality, and device status. The HART protocol lets these simultaneous communication channels be used in a complementary fashion.

The 1719 Ex I/O HART analog I/O modules support the HART protocol and perform these operations:

- Conversion of 4...20 mA analog signals to digital numeric values in engineering units that are used in the Logix controller.
- Conversion of digital numeric values in engineering units to 4...20 mA analog signals to control process devices.
- Automatic collection of dynamic process data from the connected HART field device (for example, temperature, pressure, flow, or valve position).
- Facilitation of configuration and troubleshooting of the HART field device from your control room with FactoryTalk® AssetCentre service.

This figure⁽¹⁾ shows information about the HART protocol.

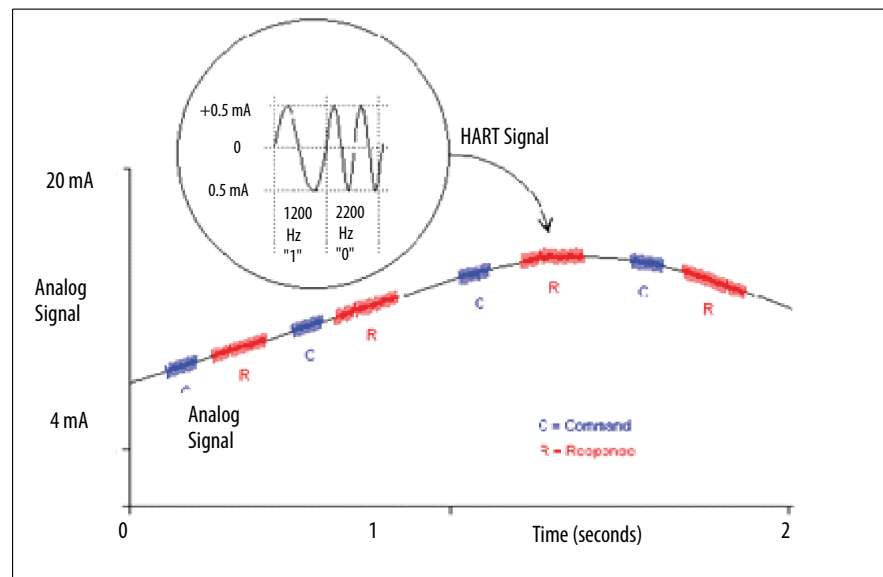

The Highway Addressable Remote Transducer (HART) protocol supports two-way digital communication, complements traditional 4...20 mA analog signals, and includes the following features:

- Predefined commands
 - Common practice
 - General purpose
 - Device specific
- Large installed base
- Worldwide support

With the 1719 Ex I/O HART analog I/O modules, both the controller and software for device maintenance and management can access field device data.

The 1719 Ex I/O HART analog I/O modules support command-response communication protocol and point-to-point wiring architecture. Multipdrop wiring architecture is not supported.

(1) The figure is from the HART Communication Protocol Specifications, April 2001, Revision 6.0, HART Communication Foundation, All Rights Reserved.

The 1719 EX I/O HART analog I/O modules act as a primary HART master. They support the use of a secondary HART master such as a handheld communicator.

Integrated HART Networks

Most 4...20 mA transmitters are available with a HART protocol interface. The type of data available depends on the type of instrument.

An example application is a HART enabled mass flowmeter. The standard mA signal from the flowmeter provides one primary measurement - flow. The mA signal with HART provides more process information. The mA signal that represents flow is still available. The HART configuration of the flowmeter can be set to communicate primary value (PV), secondary value (SV), third value (TV), and fourth value (FV). These values can represent, for example, mass flow, static pressure, temperature, total flow, etc.

Device status information is also provided via HART. Instead of one process variable, with HART the controller sees four process variables, has a check on the mA signal, and has a reading of device status. HART connectivity provides all this information with no changes to the existing 4...20 mA wiring.

FDT/DTM technology via HART connectivity also provides remote configuration and troubleshooting of field devices by using software such as FactoryTalk AssetCentre or Endress+Hauser FieldCare software.

HART-enabled I/O Modules

The 1719 Ex I/O HART analog I/O modules have built-in HART modems, so there is no need to install external HART multiplexers or clip-on HART modems. The 1719-IF4HB and 1719-CF4H modules have a separate HART modem for each channel.

Asset Management Software

You can use the HART analog I/O modules with asset management software, such as FactoryTalk AssetCentre software or Endress+Hauser FieldCare software.

HART Device Info Tab

The HART Device Info tab displays information about the attached HART field device that is collected by the HART module.

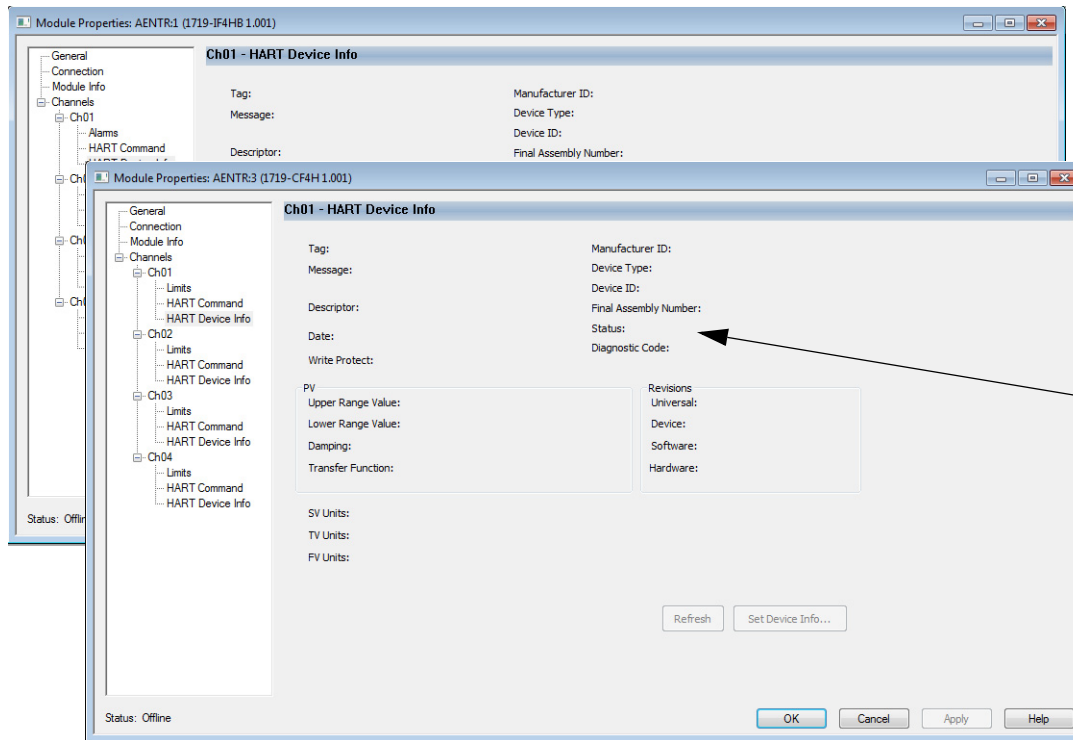

Enhanced diagnostic and status codes are available here depending on your configuration.

- If you selected a Listen-Only communication format when you created the module, this tab is not available.
- If HART is not enabled for this channel, Channel Not HART Enabled is displayed.

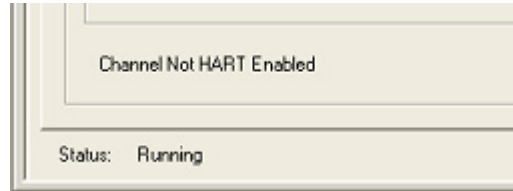

- If HART is enabled, but the HART Field Device is not responding, HART initializing is displayed.

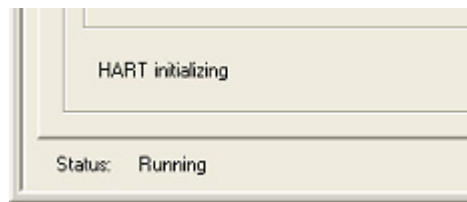
**Table 2 - HART Device Info Tab**

Parameter	Description
Channel	Click a channel to display the parameters for the corresponding channel.
Refresh	Click to update all attributes displayed on this tab for the corresponding channel.
Tag	Displays the tag name of the HART Field Device. The tag name is entered into the Field Device to indicate its location and purpose in the plant.
Message	Displays the text that was entered in the Message parameter of the HART Field Device. The use of this parameter can vary. One possible use is to store information such as who last calibrated the device, or reference to documentation.
Descriptor	Displays the Descriptor field from the HART Field Device. The Descriptor is a text message that can be stored in the device to help identify the device or it can be used for other plant specific purposes.
Date	Displays the date entered in the device. This date is often used to record the last calibration date, but it is up to the end user to maintain it. It is displayed in the format selected for your computer using the Regional and Language settings on the Control Panel.
Write Protect	Displays a Yes or No indicating if the HART Field Device is write protected. If a device is write protected, some parameters cannot be changed via HART communication. Note that sometimes devices do not indicate that the configuration changed when their write-protect setting changes. This causes the previous value to remain displayed here. You can inhibit/uninhibit the HART module to refresh this.
Manufacturer ID	Displays the manufacturer name (for example, Allen-Bradley or Endress + Hauser) or the numeric value for the manufacturer. Use the Company Identification Code table as a guide, as shown in Appendix E.
Device Type	Displays the device type for Endress + Hauser devices or a numeric value for all other manufacturer devices. Device type indicates the manufacturer's type of the device, or product name. For example, Cerabar S pressure transmitters from Endress + Hauser have Device Type 7.
Device ID	Displays a number that represents the device ID. Device ID is a serial number assigned by the manufacturer that is unique among all devices produced by that manufacturer.
Final Assembly Number	Displays a number that represents the final assembly number. The Final Assembly Number is used for identifying the materials and electronics that comprise the field device. It is normally changed when electronics or other components are upgraded in the field. In some instances, this number references a drawing number.

Table 2 - HART Device Info Tab

Parameter	Description
Status	<p>The Field Device status of the selected channel. Status has the following attributes:</p> <ul style="list-style-type: none"> • Device Malfunction • Primary Value (PV) Out of Limits • Loop Current Saturated • Loop Current Fixed • Variable Out of Limits
Diagnostic Code	<p>The diagnostic code information for each channel (up to three error values). If the device is functioning properly, OK is displayed. If the device is not working properly, numeric error values are displayed. To see the additional status in the format sent by the HART field device, send CIP service 16#4C using message instruction.</p>
PV	<p>In HART, the Primary Variable (PV) is signaled on the 4... 20 mA analog channel. It can also be read back using HART messages. In many HART devices, the relationship between the PV and the analog signal can be adjusted. This area displays the following Process Variable attributes:</p> <ul style="list-style-type: none"> • Upper Range Value - to use the same engineering units in your Logix controller as in the Field Device, enter this value in High Engineering on the Configuration tab. • Lower Range Value - to use the same engineering units in your Logix controller as in the Field Device, enter this value in Low Engineering on the Configuration tab. • Damping • Transfer Function - describes how the HART field device transforms the signal on its transducer to the PV. Usually Linear, but sometimes Square Root (for example, for flow), or other relationships.
Revision	<p>Displays the following revision attributes.</p> <ul style="list-style-type: none"> • Universal - this denotes the version of the HART specification to which the device conforms. • Device • Software • Hardware

Set Device Info (1719-IF4HB, 1719-CF4H)

For the 1719-IF4HB and 1719-CF4H modules with Configure HART Device set to Yes, a Set Device Info button appears on the HART Device Info tab. The Set Device Info button is enabled when the controller is on line and not in hard run mode. Clicking this button displays a dialog box that lets you specify tag name, message and descriptor for the HART device on the selected channel. You can enter values in the text fields or copy existing entries already stored on the device. When you click the Set button, the specified values are sent to the device via HART messages.

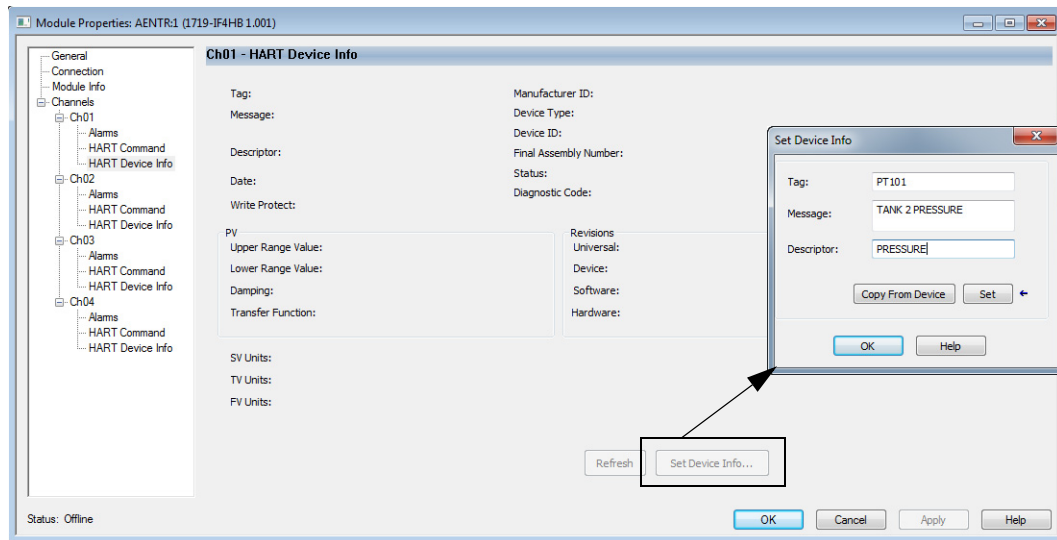

HART Command Tab - 1719-IF4HB, 1719-CF4H

When Configure HART Device is set to Yes for the 1719-IF4HB and 1719-CF4H modules, a HART Command tab appears in the Module Properties dialog.

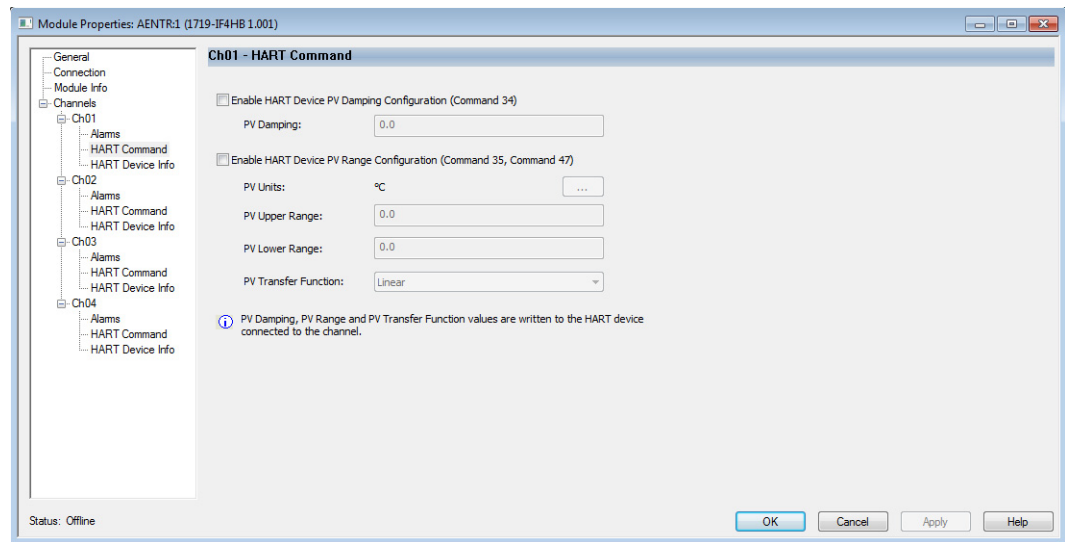

In the HART Command tab, you can specify HART device parameters for each channel. These values are sent to the HART device

Checkbox	Parameter	Description
Enable HART Device PV Damping Configuration	PV Damping	
Enable HART Device PV Range Configuration	PV Units	Engineering units for the HART PV. Choose from the dropdown list. See Appendix E for a list of unit codes.
	PV Upper Range	Highest value for PV in the specified engineering units.
	PV Lower Range	Lowest value for PV in the specified engineering units.
	PV Transfer Function	Form of the PV transfer function. Choose from the dropdown list.

Data in the Input Tags

When HART data is included in the input tag and a channel has HART enabled, the 1719 Ex I/O HART I/O module automatically collects HART data and places the most common Dynamic Process Data and Device Health information directly in the input tag.

An overview of the HART data includes the following:

- HART Faults - At the beginning of the input tag included even if you click Analog Only input data tag format. These faults indicate that HART communication is not successful or that the field device is reporting a problem such as Device Malfunction, Loop Current Saturated or PV out of Limit. For example, Ch0HARTFault is set if Ch0Config.HARTEn is 0 or if no HART Field Device is attached.

- HART Device Status - A collection of status indicators that reflect the HART communication details and overall device health.
 - Init - Module is searching for a HART device.
 - Fault - HART communication is not successful. If this is 1 and Initializing is 0, probable cause is HART is not enabled on this channel.
 - Message Ready - A HART pass-through message reply is ready to be collected by using the Pass-through Query CIP message. For information on using CIP MSGs to access HART data, refer to the ControlLogix HART Analog I/O Modules User manual, publication [1756-UM333](#).
 - Current Fault - The analog current doesn't match the readback of the current received over the HART communication. This might be caused by an inaccurate field device, faulty wiring, or water in the conduit. Sometimes a rapid change in the signal results in a transient current fault as the analog and digital representations are sampled at slightly different times and at different places in the signal path.
 - Configuration Changed - The Field Device configuration has changed and new Field Device configuration information can be obtained from the module via CIP MSG GetDeviceInfo, which will clear this bit.
 - ResponseCode - HART Communication Status or Response Code. 0 means success.
 - FieldDeviceStatus - HART device health, such as PV out of range or device malfunction. See [Appendix C](#) for details.
 - UpdatedStatusReady - indicates new device diagnostic information is available, which can be obtained by sending a CIP Message with Service 4C.

HART Dynamic Variables

Most HART devices are capable of measuring several different process characteristics or of deriving other measurements from directly sensed measurements. For example, many differential pressure transmitters can also sense the process temperature and can calculate the flow, or they might calculate the volume in a tank based on a measurement of its head pressure and knowledge of tank geometry and product density.

The most important of these direct or derived measurements is assigned to the PV (Primary Variable) and the analog signal will represent its value. Additional measurements can be read from the HART field device over the HART communication protocol. HART provides a standard message for reading four of the dynamic variables, called PV, SV, TV, and FV (sometimes called QV). These four dynamic variables are the four measurements of interest to a controller.

These four dynamic variables - PV, SV, TV, and FV - are automatically collected from the HART field device and placed in the module's input tag in HART.ChxPV (for Analog and HART PV data format) or Chxx.PV (for Analog and HART by Channel data format). In some HART devices, the choice of which of the available measurements to assign to PV, SV, TV, and FV can be

changed via configuration. In other more simple devices, the assignment is done at the factory and cannot be changed.

An example for a Flow Meter might be:

- PV - Primary Variable. Flow Rate in Liters per Minute.
- SV - Secondary Variable. Process Temperature in °C.
- TV - Third or Tertiary Variable. Product Density in Grams per Cubic Centimeter.
- FV - Fourth or Quaternary Variable

An example for a Valve Positioner might be:

- PV - Primary Variable. Commanded position in %.
- SV - Secondary Variable. Actual position in %.
- TV - Third or Tertiary Variable. Air Pressure in PSI.
- FV - Fourth or Quaternary Variable. Loop current in mA.

In addition to the measurement value, HART devices can provide status information that indicates the quality of the measurement.

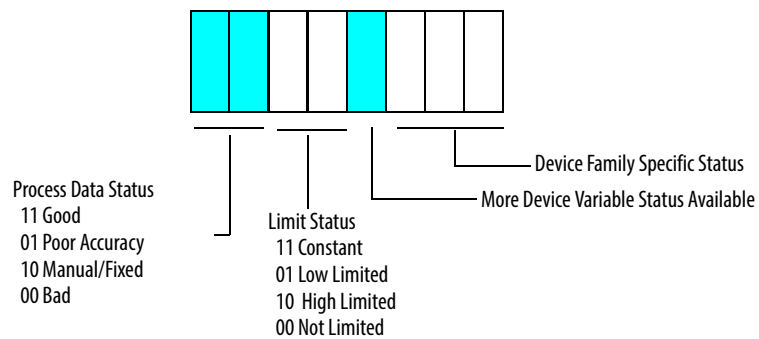

For example, if a valve positioner cannot open any further, it should set its HART.ChxSVStatus to 2#11100000 to indicate that the actual position value in the SV is Good (accurately measured) but is the subject of a High Limit. This status information can be used for windup control in PID loops and for other diagnostic purposes.

The module collects the PV, SV, TV, and FV data as described in [Table 3](#).

Table 3 - Dynamic Variable Assignment

HART Version	HART Device Reports PV, SV, TV, FV Assignments in Command 50	HART Command Used by 1719 Module to Collect PV, SV, TV, FV	Device Variable Codes Used in Command 9 for PV, SV, TV, FV
5	N/A	3	N/A
6	No	3	N/A
	Yes	9	As Reported in Command 50
7 or later	No	9	246, 247, 248, 249
	Yes		As Reported in Command 50

Command 3 does not provide PVStatus, SVStatus, TVStatus, or FVStatus, so HART devices that indicate Command 3 as shown in [Table 3](#) will have their Dynamic Variable Status values reported based on the communication status with the HART field device. If the Dynamic Variables are being collected without communication error, the Status value is 16#C0 (2#11000000), which means good. Otherwise, it is 0, meaning bad.

Some devices don't have four dynamic variables. In this case, they can report a NaN value to indicate they have no valid value for that parameter.

The dynamic variables do not update as fast as the analog signal. The actual rate depends on the number of channels configured for HART, the number of pass-through message commands, the presence of handheld communicators or other secondary masters, and the response speed of the field device.

IMPORTANT Verify that the actual HART update rate is appropriate for your application. Remember that pass-through message traffic, additional status information, secondary masters, and communication errors can delay the update rate.

IMPORTANT Verify that HART data is valid by checking ChxFault, HARTFault, and values such as PVStatus and SVStatus.

How the Module Automatically Collects Data

The 1719 Ex I/O HART analog module automatically sends HART messages to characterize the HART field device and collect the dynamic variables. It also collects additional status information when the device indicates it is available. When the device indicates its configuration has changed, HART messages are sent to reread the configuration information so that a current copy is cached in the modules.

The diagram on [page 55](#) shows the general flow of the start-up characterization, response to a new configuration, and cyclic scanning of dynamic variables. Not shown are periodic checks of the current and reading the additional status information.

In addition to the HART activities outlined in the diagram, if there are HART pass-through messages to send, they are interleaved in the auto scanning. Logix controllers can send pass-through messages using CIP MSG instructions, and Asset Management systems can send them. For more information, refer to the ControlLogix HART Analog I/O Modules User manual, publication [1756-UM333](#).

If the HART field device configuration is changed—from a handheld, asset management, or device faceplate—cyclic reading of the Dynamic Variables pauses briefly while the configuration changes are assimilated. The HART.ChxDeviceStatus.ConfigurationChanged status is set when the updated configuration is retrieved from the HART field device and stored in the module to indicate that new data is available for GetDeviceInfo CIP MSG.

For more information, refer to the ControlLogix HART Analog I/O Modules User manual, publication [1756-UM333](#).

Figure 1 - 1719-IF4HB and 1719-CF4H Flow Chart

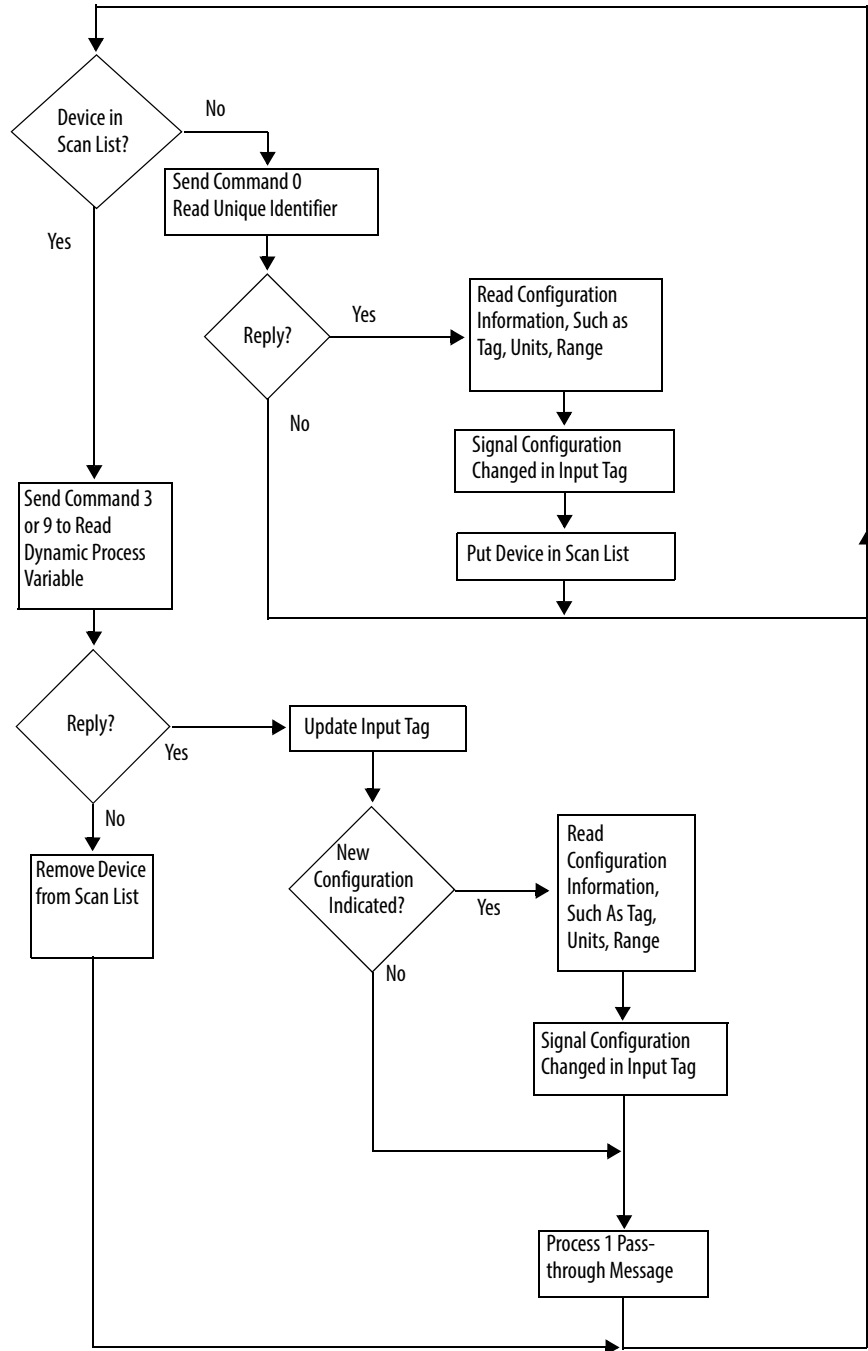

Getting HART Data by Using CIP MSG

For information about how to use HART data in your Logix controller via MSG instructions, refer to the ControlLogix HART Analog I/O Modules User manual, publication [1756-UM333](#).

HART Modules Used with Asset Management Software

Considerations for Asset Management Systems

The following must be considered before using the I/O modules with asset management systems, such as FactoryTalk AssetCentre or Endress+Hauser FieldCare systems.

- HART must be enabled before any asset management system access is possible, including scanning for multiplexers, if supported by your asset management software. You do not need to include HART PV or HART by Channel data in your input tag, but you do need to check the Enable HART box on the Configuration tab of the Module Properties dialog box.
- The Logix controller must be connected to the I/O module. If the Logix controller is not connected, the module configuration was not sent to the HART module, and the channel is not yet configured for HART access.
- If you use a handheld HART communicator and configuration tool, such as Rosemount 275 or Meriam, configure the tool as the secondary master. The Meriam handheld has a high-speed mode, which assumes it is the only master present. In this mode, the handheld may conflict with the I/O module. Usually, the Meriam handheld automatically detects the proper setting, but if not, set it manually.
- The ConfigurationChanged indication in the Field Device Status is automatically reset by the I/O module. Asset management systems might miss this indication if they are offline at the time of a change.
- A separate configuration-changed indication is in the field device status for the primary master (1719-IF4HB or 1719-CF4H) and secondary master (handheld, for example). The I/O modules do not reset the secondary master configuration changed status.

HART traffic from asset management pass-through messages or from secondary masters slows the update rate of HART data in the controller or other pass-through message clients. In the 1719-IF4HB or 1719-CF4H modules, extra traffic on one channel also affects other channels.

Frequently Asked Questions

Read this section for answers to frequently asked questions.

How do you use 1719 Ex I/O HART analog I/O modules as part of an asset management system?

HART I/O modules let most asset management software packages communicate through the modules to HART field devices. Use RSLinx software to let the asset

management software communicate through the NetLinx networks and 1719 backplane.

What else is required to use asset management software with a 1719 Ex I/O HART analog I/O module?

For Field Device Tool (FDT)/Device Type Manager (DTM) based asset management software such as E+H FieldCare, you use communication DTMs from Rockwell Automation. These same communication DTMs also work in FactoryTalk AssetCentre software.

What is FDT/DTM?

FDT/DTM is a technology for managing intelligent devices.

E+H FieldCare asset management software is an FDT frame application. The frame application runs the DTM files. The DTM files are executable files that are provided by control and device vendors. There are communication DTMs and device DTMs.

We provide communication DTMs for components in the integrated architecture. Companies such as Endress+Hauser and Metso provide device DTMs for their instruments and valves. The device DTMs provide visualization of the parameters that are needed to configure, monitor, and maintain the devices.

See <http://www.fdtgroup.org> for more information on FDT/DTM technology and to search for registered DTMs.

What communication DTMs are used with the 1719 Ex I/O HART analog I/O modules?

Go to the Rockwell Automation Product Compatibility and Download Center (<http://www.rockwellautomation.com/rockwellautomation/support/pcdc.page>), click the Download link, and search for DTM to obtain the DTMs.

Can I get asset management software from Rockwell Automation?

FactoryTalk AssetCentre provides you with a centralized tool for securing, managing, versioning, tracking and reporting automation related asset information across your entire facility. It can do this automatically, with limited additional management oversight or work from employees. FactoryTalk AssetCentre can impact uptime, productivity, quality, employee safety or regulatory compliance. For more information, see <http://www.rockwellautomation.com/rockwellsoftware/products/factorytalk-asset-center.page?>

What if a DTM is not available for my HART field device?

A generic DTM is available (included with FieldCare) that provides basic access to devices.

Notes:

Troubleshooting

Topic	Page
Communication Errors	59
Signal Faults	60



WARNING: Risk of explosion

When work is performed on the distributed I/O station in hazardous areas, there is a risk of explosion from spark formation.

Before embarking on any work on the distributed I/O station, familiarize yourself with the operating instructions for the components and their certificates of compliance, and read the 1719 Ex I/O User Manual.

Communication Errors

See the following table for the recommended actions when troubleshooting communication errors.

Recommended Action for Communication Errors

Error	Remedy
Communication error on EtherNet/IP	<ul style="list-style-type: none"> • Check that the cables are connected. • Check that the transmitting and receiving lines are wired correctly and have not been swapped. • Check that the nodes are positioned in linear, star, or ring form and without branches. • In the configuration software, check that the selected address is the same as the distributed I/O station address.
The software cannot locate an adapter when establishing the connection	Check that the adapter is plugged in correctly.

Signal Faults

See the following table for the recommended actions when troubleshooting signal faults.

Recommended Action for Signal Faults

Error	Remedy
Faulty signal	<ul style="list-style-type: none"> • Check if there is a short circuit or lead breakage within the circuit. • Check that the field devices and sensors are working properly. • Check the communication path to the I/O module. • If necessary, replace the I/O module.
All signals for a module are faulty	<ul style="list-style-type: none"> • Check that the power supply is working properly. • Check the bus connection.
The output module switches off	<ul style="list-style-type: none"> • Communication with the adapter is interrupted. • Check that the I/O module is plugged into the backplane properly.
Input module sporadically delivers no measured values	<ul style="list-style-type: none"> • Communication with the adapter is interrupted. • Check that the I/O module is plugged into the backplane properly.
Measured values occasionally incorrect	<ul style="list-style-type: none"> • Check whether the measured value is being distorted by external influences. • Check that the shielding is intact.
I/O module reported to be faulty	<ul style="list-style-type: none"> • Check that the correct I/O module is plugged in. • Check that the green LED on the I/O module is lit and that the I/O module is correctly plugged in.

Technical Data

Topic	Page
Power Supply	61
Mechanical Data	61
Ambient Conditions	62



ATTENTION: Damage to equipment

Equipment can be damaged by voltages that are too high, for example, in temporary faulty operation.

Ensure that the supply voltage of the power supplies used in Zone 2 does not exceed 33.6V DC (24V x 1.4).

Power Supply

Rated voltage: 24V DC

Use a suitable power supply to implement another supply voltage of 24V DC. The maximum permitted supply voltage for an upstream power supply is 253V AC.

Power consumption:

- Max. 30 W for Zone 2 applications
- Max. 45 W for application in safe area

Mechanical Data

Weight:

- Backplane 1719-A22: Approx. 2170 g
- Backplane 1719-A8: Approx. 1010 g
- Backplane 1719-A24: Approx. 1800 g

Dimensions:

- Backplanes: See [Design and Dimensions on page 20](#)
- Single-width I/O modules: 16 x 100 x 103 mm
- Dual-width I/O modules: 32 x 100 x 103 mm
- Adapters and power supplies: 32 x 100 x 103 mm

Ambient Conditions

Ambient temperature:

- Power supplies, I/O modules with non-intrinsically safe circuits:
-20 °C ... 60 °C (-4 °F ... 140 °F)
- Adapters, I/O modules with intrinsically safe circuits:
-20 °C ... 60 °C (-4 °F ... 140 °F)

Storage temperature: -25 °C ... 85 °C (-13 °F ... 185 °F)

Relative humidity: 95% noncondensing

Designed for pollution degree 2

Damaging gas: Designed for operation in environmental conditions according to ISA-S71.04-1985, severity level G3

Additional HART Protocol Information

This appendix discusses these topics.

Topic	Page
Message Structure	64
Response Code and Field Device Status	65
HART PV, SV, TV, and FV Status	71

This appendix describes the HART protocol and provides references for additional information about the protocol. Consult the HART protocol specification and vendor-provided documentation for specifics on HART commands.

This appendix provides the following:

- HART protocol background information
- Common practice command sets
- Extended command sets
- References to additional information

HART Field Communication Protocol is widely accepted in the industry as the standard for digitally enhanced 4...20mA communication with smart field instruments. The HART Protocol message structure, command set, and status are discussed in this appendix.

The HART command set is organized into these groups and provides read and write access to a wide array of information available in smart field instruments:

- Universal commands provide access to information that is useful in normal plant operation such as the instrument manufacturer, model, tag, serial number, descriptor, range limits, and process variables. All HART devices must implement universal commands.
- Common practice commands provide access to functions that can be carried out by many devices.
- Device specific commands provide access to functions that can be unique to a particular device.

Message Structure

Read this section for a description of transaction procedure, character coding, and message structure of the HART protocol. These correspond to layer 2 (data-link layer) of the OSI protocol reference model.

Master-slave Operation

HART is a master-slave protocol. This means that each message transaction is originated by the master; the slave (field) device replies when it receives a command message addressed to it. The reply from the slave device acknowledges that the command was received and can contain data requested by the master.

Multiple Master Operation

The HART protocol provides for two active masters in a system: one primary and one secondary. The two masters have different addresses. Each can positively identify replies to its own command messages. The 1719-IF4HB or 1719-CF4H module acts as primary master. A secondary master, such as a handheld configuration device, may also be connected.

Transaction Procedure

HART is a half-duplex protocol. After completion of each message, the FSK carrier signal must be switched off to let the other station transmit. The carrier control timing rules state that the carrier should be turned on not more than 5 bit times before the start of the message (that is, the preamble) and turned off not more than 5 bit times after the end of the last byte of the message (the checksum).

The master is responsible for controlling message transactions. If there is no reply to a command within the expected time, the master should retry the message. After a few retries, the master should abort the transaction, because presumably the slave device or the communication link has failed.

After each transaction is completed, the master should pause for a short time before sending another command, to provide an opportunity for the other master to break in if it wishes. This way, two masters (if they are present) take turns at communicating with the slave devices. Typical message lengths and delays allow two transactions per second.

Burst Mode

Burst mode is not supported by the 1719 HART analog modules.

Response Code and Field Device Status

Two bytes of status also called the response code and field device status are included in every reply message from a field or slave device. These two bytes convey communication errors, command response problems, and field device status. If an error is detected in the outgoing communication, the most significant bit (bit 7) of the first byte is set to 1 and the details of the error are reported in the rest of that byte. The second byte is then all zeros.

Communication errors are typically those that would be detected by a UART (parity overrun and framing errors). The field device also reports overflow of its receive buffer and any discrepancy between the message content and the checksum received.

In the Studio 5000 software application, if the leftmost bit of the ResponseCode is set, it displays a negative number. In this case, the ResponseCode represents a communication fault. Change the display format to hexadecimal to interpret communication status.

If the leftmost bit of the ResponseCode is 0 (value 0..127), then there was no communication error and the value is a ResponseCode from the HART field device. Response codes indicate if the device performed the command. 0 means no error. Other values are errors or warnings. To understand the ResponseCode, contact your HART field device manufacturer or the HART specification.

See [Table 1](#) for descriptions of the response code and the field device status.

Table 1 - Response Codes and Field Device Status

Response Code		Description	
If Bit 7 is	And Bits 6...0 are		
1	16#40	Parity Error	Vertical parity error - The parity of one or more of the bytes received by the device was not odd
1	16#20	Overrun Error	Overrun error - At least one byte of data in the receive buffer of the UART was overwritten before it was read (for example, the slave did not process incoming byte fast enough)
1	16#10	Framing Error	Framing error - The Stop Bit of one or more bytes received by the device was not detected by the UART (for example, a mark or 1 was not detected when a Stop Bit should have occurred)
1	16#08	Checksum Error	Longitudinal parity error - The Longitudinal Parity calculated by the device did not match the Check Byte at the end of the message
1	16#04	(Reserved)	Reserved - Set to zero
1	16#02	RX Buffer Overflow	Buffer overflow - The message was too long for the receive buffer of the define
1	16#01	(undefined)	Reserved - Set to zero
0	0	No command specific error	
0	1	(undefined)	
0	3	Value too large	
0	4	Value too small	
0	5	Not enough bytes in command	
0	6	Transmitter-specific command error	
0	7	In Write-protect mode	
0	8	Update Failed - Update In Progress - Set to Nearest Possible Value	
0	9	Applied Process Too High - Lower Range Value Too High - Not In Fixed Current Mode	

Table 1 - Response Codes and Field Device Status (Continued)

Response Code		Description
If Bit 7 is	And Bits 6...0 are	
0	10	Applied Process Too Low - Lower Range Value Too Low - MultiDrop Not Supported
0	11	In MultiDrop Mode - Invalid Transmitter Variable Code - Upper Range Value Too High
0	12	Invalid Unit Code - Upper Range Value Too Low
0	13	Both Range Values Out of Limits
0	14	Pushed Upper Range Value Over Limit - Span Too Small
0	16	Access restricted
0	32	Device busy
0	64	Command not implemented

If no error was detected in the outgoing communication, the second byte contains status information pertaining to the operational state of the field or slave device.

Table 2 - Field Device Status Bit Mask Definitions

Bit	Bit Mask	Definition
7	16#80	Device malfunction - The device detected a serious error or failure that compromises device operation
6	16#40	Configuration changed - An operation was performed that changed the device's configuration
5	16#20	Cold start - A power failure or device reset occurred
4	16#10	More status available - More status information is available via command 48, Read Additional Status Information
3	16#08	Loop current fixed - The loop current is being held at a fixed value and is not responding to process variations
2	16#04	Loop current saturated - The loop current has reached its upper or lower endpoint limit and cannot increase or decrease any further
1	16#02	Non-primary variable out of limits - A device variable not mapped to the PV is beyond its operating limits
0	16#01	Primary variable out of limits - The PV is beyond its operating limit

IMPORTANT The 16# means this number is Hex display style.

Table 3 - HART Universal Commands

Command		Data in Command			Data in Reply			Contained in	
No.	Function	Byte	Data	Type ⁽¹⁾	Byte	Data	Type ⁽¹⁾	Input Tag	CIP MSG
0	Read Unique Identified		None		0	254 (expansion)			X
					1	Manufacturer identification code			X
					2	Manufacturer device type code			X
					3	Number of preambles required			X
					4	Universal command revision			X
					5	Device-specific command revision			X
					6	Software revision			X
					7	Hardware revision			X
					8	Device function flags ⁽²⁾	(H)		X
					9...11	Device ID number	(B)		X
1	Read primary variable				0	PV units code	(F)		X
					1...4	Primary variable		X	X
2	Read current and percent of range		None		0...3	Current (mA)	(F)	X	X
					4...7	Primary variable %	(F)	X	X

Table 3 - HART Universal Commands

Command		Data in Command			Data in Reply			Contained in	
No.	Function	Byte	Data	Type ⁽¹⁾	Byte	Data	Type ⁽¹⁾	Input Tag	CIP MSG
3	Read current and four (predefined) dynamic variables		None		0...3 4 5...8 9 10...13 14 15...18 19 20...23	Current (mA) PV units code Primary variable SV units code Secondary variable TV units code Third variable FV units code Fourth variable ⁽³⁾			x x x x x x x x x
6	Write polling address	0	Polling address			As in command			
11	Read unique identifier associated with tag	0...5	Tag	(A)	0...11				
12	Read message		None		0...23	Message (32 characters)	(A)		x
13	Read tag, descriptor, date				0...5 6...17 18...20	Tag (8 characters) Descriptor (16 characters) Date	(A) (A) (D)		x x x
14	Read PV sensor information				0...2 3 4...7 8...11 12...15	Sensor serial number Units code for sensor limits and min span Upper sensor limit Lower sensor limit Min span	(B) (F) (F) (F)		
15	Read output information				0 1 2 3...6 7...10 11...14 15 16	Alarm select code Transfer function code PV/range units code Upper range value Lower range value Damping value (seconds) Write-protect code Private-label distributor code	(F) (F) (F)		x x x x x x
16	Read final assembly number					0...2	Final assembly number	(B)	
17	Write message	0...23	Message (32 characters)	(A)		As in command			
18	Write tag, descriptor, date	0...5 6...17 18...20	Tag (8 characters) Descriptor (16 characters) Date	(A) (A) (D)					
19	Write final assembly number	0...2	Final assembly number	(B)					
48	Read additional device status		Starting in HART version 7, the data in the command could be the same as in the reply.		0...5 6...7 8 9 10 11 12 13 14...24	Device-specific status Operational modes Standardized status 0 Standardized status 1 Analog channel saturated Standardized status 2 Standardized status 3 Analog channel fixed ⁽⁴⁾ Device-specific status	s ⁽⁵⁾		x x x x x x x x x

(1) (A) = Packed ASCII, (B) = 3-byte integer, (D) = Date, (F) = Floating Point (HART format), (H) = HART flag
 (2) Bit 6 = multisensor device. Bit 1 = EEPROM control required. Bit 2 = protocol bridge device.
 (3) Truncated after last supported variable.
 (4) 24 bits each LSB...MSB refers to A0 #1...24.
 (5) Sint []

Table 4 - Common Practice Commands

Command		Data in Command			Data in Reply			Contained in	
No.	Function	Byte	Data	Type ⁽⁶⁾	Byte	Data	Type ⁽⁶⁾	Input Tag	CIP MSG
51	Write dynamic variable assignments	0 1 2 3	PV transmitter variable code SV transmitter variable code TV transmitter variable code FV transmitter variable code			As in command			
52	Set transmitter variable zero	0	Transmitter variable code						
53	Write transmitter variable units		Transmitter variable code						
54	Read transmitter variable information		Transmitter variable code		0 1...3 4 5...8 9...12 13...16	Transmitter variable code Transmitter variable sensor serial Transmitter variable limits units code Transmitter variable upper limit Transmitter variable lower limit Transmitter variable damping value (seconds)	(F) (F) (F)		
55	Write transmitter variable damping value	0 1...4	Transmitter variable code Transmitter variable damping value (seconds)			As in command			
56	Write transmitter variable sensor serial number	0 1...3	Transmitter variable code Transmitter variable sensor			As in command			
57	Read unit tag, description, date		None		0...5 6...17 18...20		(A) (A) (D)		x x x x
58	Write unit tag, descriptor, date	0...5 6...17 18...20 0	Unit tag (8 characters) Unit descriptor (16 characters) Unit date	(A) (A) (D)					
59	Write number of response preambles	0	Number of response preambles						
60	Read analog output and percent of range	0	Analog output number code		0 1 2...5 6...9	Analog output number code Analog output units code Analog output level Analog output percent of range			
61	Read dynamic variables and PV analog output		None		0 1...4 5 6...9 10 11...14 15 16...19 20 21...24	PV analog output units code PV analog output level PV units code Primary variable SV units code Secondary variable TV units Tertiary variable FV units code Fourth variable	(F) (F) (F) (F) (F) (F)	x x x x x x	x x x x x x

Table 4 - Common Practice Commands

Command		Data in Command			Data in Reply			Contained in	
No.	Function	Byte	Data	Type ⁽⁶⁾	Byte	Data	Type ⁽⁶⁾	Input Tag	CIP MSG
62	Read analog outputs	0	Analog output number; code for slot 0	0	Slot 0 analog output number code Slot 0 Slot 0 level Slot 1 Slot 1 Slot 1 level Slot 2 Slot 2 Slot 2 level Slot 3 Slot 3 Slot 3 level ⁽⁸⁾	(F)			
		1	Analog output number; code for slot 1	1					
		2	Analog output number; code for slot 2	2...5					
		3 ⁽²⁾	Analog output number; code for slot 3 ⁽⁴⁾	6					
63	Read analog output information	0	Analog output number code	0	Analog output number code Analog output alarm select code Analog output transfer function code Analog output range units code Analog output upper-range value Analog output lower-range value Analog output additional damping value (seconds)	(F) (F) (F)			
		1		1					
		2		2					
		3		3					
		4...7		4...7					
		8...11		8...11					
		12...15		12...15					
64	Write analog output additional damping value	0	Analog output number code	(F)	As in command				
		1...4	Analog output additional damping value (seconds)						
65	Write analog output range value	0	Analog output number code	(F) (F)					
		1	Analog output range units code						
		2...5	Analog output upper-range value						
		6...9	Analog output lower-range value						
66	Enter/exit Fixed Analog Output mode	0	Analog output number code	(F)					
		1	Analog output units code						
		2...6	Analog output level ⁽⁵⁾						
67	Trim analog output zero	0	Analog output number code	(F)					
		1	Analog output units code						
		2...6	Externally measured analog output level						
68	Trim analog output gain	0	Analog output number code	(F)					
		1	Analog output units code						
		2...6	Externally measured analog output level						
69	Write analog output transfer function	0	Analog output number code						
		1	Analog output transfer function code						
70	Read analog output endpoint values	0	Analog output number code		0	Analog output number code			
					1	Analog output endpoint units code			
					2...5	Analog output upper endpoint value			
					6...9	Analog output lower endpoint value			

Table 4 - Common Practice Commands

Command		Data in Command			Data in Reply			Contained in	
No.	Function	Byte	Data	Type ⁽⁶⁾	Byte	Data	Type ⁽⁶⁾	Input Tag	CIP MSG
107	Write Burst mode transmitter variables (for command 33)	0 1 2 3	Transmitter variable code for slot 0 Transmitter variable code for slot 1 Transmitter variable code for slot 2 Transmitter variable code for slot 3			As in command			
108	Write Burst mode command number	0	Burst mode command number			As in command			
109	Burst mode control	0	Burst mode control code (0 = exit, 1 = enter)						
110	Read all dynamic variables		None		0 1...4 5 6...9 10 11...14 15 16...19	PV units code PV value SV units code SV value TV units code TV value FV units code FV value	(F) (F)	x x x x x x	x x x x x x

- (1) 0 = exit Fixed Current mode.
(2) Truncated after last requested code.
(3) 0 = burn EEPROM, 1 = copy EEPROM to RAM.
(4) Truncated after last requested code.
(5) Not a number exits Fixed-output mode.
(6) (A) = Packed ASCII, (B) = 3-byte integer, (D) = Date, (F) = Floating Point (HART format), (H) = HART flag
(7) Truncated after last requested code. Truncated after last requested variable.
(8) Truncated after last requested level.

HART PV, SV, TV, and FV Status

HART PV, SV, TV, and FV are dynamic variables that contain the values of device variables, which are various direct or indirect process measurements performed by the HART field device.

Some devices let a set of their internal device variables be mapped to the PV, SV, TV, FV dynamic variables that are automatically collected in the 1719-IF4HB and 1719-CF4H Input Tag.

This mapping is part of the field device configuration, usually performed via a handheld configurator or asset management system, such as FactoryTalk AssetCentre or Endress+Hauser FieldCare system.

HART PVStatus, SVStatus, TVStatus, FVStatus are known as Device Variable Status values. These Status values are composed of groups of bits that indicate the quality of the associated device variable.

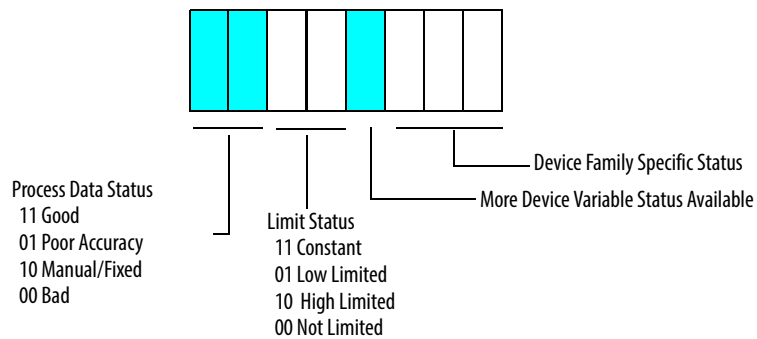

The Limit Status can be used to control windup in PID loops.

Table 5 - HART PV, SV, TV, and FV Status Values

HART PV, SV, TV FV Status Values			Quality		Limit		More Status Available?		Device Family Specific	
Decimal	Hex	Binary							Binary	Decimal
0	0	00000000	00	Bad	00	Not Limited	0	No	000	0
1	1	00000001	00	Bad	00	Not Limited	0	No	001	1
2	2	00000010	00	Bad	00	Not Limited	0	No	010	2
3	3	00000011	00	Bad	00	Not Limited	0	No	011	3
4	4	00000100	00	Bad	00	Not Limited	0	No	100	4
5	5	00000101	00	Bad	00	Not Limited	0	No	101	5
6	6	00000110	00	Bad	00	Not Limited	0	No	110	6
7	7	00000111	00	Bad	00	Not Limited	0	No	111	7
8	8	00001000	00	Bad	00	Not Limited	1	Yes	000	0
9	9	00001001	00	Bad	00	Not Limited	1	Yes	001	1
10	A	00001010	00	Bad	00	Not Limited	1	Yes	010	2
11	B	00001011	00	Bad	00	Not Limited	1	Yes	011	3
12	C	00001100	00	Bad	00	Not Limited	1	Yes	100	4
13	D	00001101	00	Bad	00	Not Limited	1	Yes	101	5
14	E	00001110	00	Bad	00	Not Limited	1	Yes	110	6
15	F	00001111	00	Bad	00	Not Limited	1	Yes	111	7
16	10	00010000	00	Bad	01	Low Limited	0	No	000	0
17	11	00010001	00	Bad	01	Low Limited	0	No	001	1
18	12	00010010	00	Bad	01	Low Limited	0	No	010	2
19	13	00010011	00	Bad	01	Low Limited	0	No	011	3
20	14	00010100	00	Bad	01	Low Limited	0	No	100	4
21	15	00010101	00	Bad	01	Low Limited	0	No	101	5
22	16	00010110	00	Bad	01	Low Limited	0	No	110	6
23	17	00010111	00	Bad	01	Low Limited	0	No	111	7

Table 5 - HART PV, SV, TV, and FV Status Values

24	18	00011000	00	Bad	01	Low Limited	1	Yes	000	0
25	19	00011001	00	Bad	01	Low Limited	1	Yes	001	1
26	1A	00011010	00	Bad	01	Low Limited	1	Yes	010	2
27	1B	00011011	00	Bad	01	Low Limited	1	Yes	011	3
28	1C	00011100	00	Bad	01	Low Limited	1	Yes	100	4
29	1D	00011101	00	Bad	01	Low Limited	1	Yes	101	5
30	1E	00011110	00	Bad	01	Low Limited	1	Yes	110	6
31	1F	00011111	00	Bad	01	Low Limited	1	Yes	111	7
32	20	00100000	00	Bad	10	High Limited	0	No	000	0
33	21	00100001	00	Bad	10	High Limited	0	No	001	1
34	22	00100010	00	Bad	10	High Limited	0	No	010	2
35	23	00100011	00	Bad	10	High Limited	0	No	011	3
36	24	00100100	00	Bad	10	High Limited	0	No	100	4
37	25	00100101	00	Bad	10	High Limited	0	No	101	5
38	26	00100110	00	Bad	10	High Limited	0	No	110	6
39	27	00100111	00	Bad	10	High Limited	0	No	111	7
40	28	00101000	00	Bad	10	High Limited	1	Yes	000	0
41	29	00101001	00	Bad	10	High Limited	1	Yes	001	1
42	2A	00101010	00	Bad	10	High Limited	1	Yes	010	2
43	2B	00101011	00	Bad	10	High Limited	1	Yes	011	3
44	2C	00101100	00	Bad	10	High Limited	1	Yes	100	4
45	2D	00101101	00	Bad	10	High Limited	1	Yes	101	5

Note that this Device Variable Status byte is a new HART feature in HART protocol revision 6 and many HART devices do not yet support it. For those devices, the module creates a status value based on the communication status of the device.

If the PV, SV, TV, FV are being collected without communication errors, the value is set to 16#C0, indicating Good, Not Limited. Otherwise, the value is set to 0, indicating Bad, Not Limited, no specific information available.

Notes:

Engineering Unit Code Numbers

Code Number Details

This table maps engineering unit code numbers to their meaning and abbreviations. These codes are used in the process variable range display.

Unit Codes	Description from HART Specification	Abbreviated Units
1	inches of water at 20 °C (68 °F)	inH2O (20 °C or 68 °F)
2	inches of mercury at 0 °C (32 °F)	inHg (0 °C or 32 °F)
3	feet of water at 20 °C (68 °F)	ftH2O (20 °C or 68 °F)
4	millimeters of water at 20 °C (68 °F)	mmH2O (20 °C or 68 °F)
5	millimeters of mercury at 0 °C (32 °F)	mmHg (0 °C or 32 °F)
6	pounds per square inch	psi
7	bars	bar
8	millibars	mbar
9	grams per square centimeter	g/square cm
10	kilograms per square centimeter	kg/square cm
11	pascals	Pa
12	kilopascals	kPa
13	torr	torr
14	atmospheres	atm
15	cubic feet per minute	cubic ft/min
16	gallons per minute	usg/min
17	liters per minute	L/min
18	imperial gallons per minute	impgal/min
19	cubic meter per hour	cubic m/h
20	feet per second	ft/s
21	meters per second	m/s
22	gallons per second	usg/s
23	million gallons per day	million usg/d
24	liters per second	L/s
25	million liters per day	ML/day
26	cubic feet per second	cubic ft/s
27	cubic feet per day	cubic ft/d
28	cubic meters per second	cubic m/s
29	cubic meters per day	cubic m/d
30	imperial gallons per hour	impgal/h
31	imperial gallons per day	impgal/d

Unit Codes	Description from HART Specification	Abbreviated Units
32	Degrees Celsius	°C
33	Degrees Fahrenheit	°F
34	Degrees Rankine	°R
35	Kelvin	°K
36	millivolts	mV
37	ohms	ohm
38	hertz	hz
39	milliamperes	mA
40	gallons	usg
41	liters	L
42	imperial gallons	impgal
43	cubic meters	cubic m
44	feet	ft
45	meters	m
46	barrels	bbl
47	inches	in
48	centimeters	cm
49	millimeters	mm
50	minutes	min
51	seconds	s
52	hours	h
53	days	d
54	centistokes	centistokes
55	centipoise	cP
56	microsiemens	microsiemens
57	percent	%
58	volts	V
59	pH	pH
60	grams	g
61	kilograms	kg
62	metric tons	t
63	pounds	lb
64	short tons	short ton
65	long tons	long ton
66	milli siemens per centimeter	millisiemens/cm
67	micro siemens per centimeter	microsiemens/cm
68	newton	N
69	newton meter	N m
70	grams per second	g/s
71	grams per minute	g/min

Unit Codes	Description from HART Specification	Abbreviated Units
72	grams per hour	g/h
73	kilograms per second	kg/s
74	kilograms per minute	kg/min
75	kilograms per hour	kg/h
76	kilograms per day	kg/d
77	metric tons per minute	t/min
78	metric tons per hour	t/h
79	metric tons per day	t/d
80	pounds per second	lb/s
81	pounds per minute	lb/min
82	pounds per hour	lb/h
83	pounds per day	lb/d
84	short tons per minute	short ton/min
85	short tons per hour	short ton/h
86	short tons per day	short ton/d
87	long tons per hour	long ton/h
88	long tons per day	long ton/d
89	deka therm	Dth
90	specific gravity units	specific gravity units
91	grams per cubic centimeter	g/cubic cm
92	kilograms per cubic meter	kg/cubic m
93	pounds per gallon	lb/usg
94	pounds per cubic feet	lb/cubic ft
95	grams per milliliter	g/mL
96	kilograms per liter	kg/L
97	grams per liter	g/L
98	pounds per cubic inch	lb/cubic in
99	short tons per cubic yard	short ton/cubic yd
100	degrees twaddell	°Tw
101	degrees brix	°Bx
102	degrees baume heavy	BH
103	degrees baume light	BL
104	degrees API	°API
105	percent solids per weight	% solid/weight
106	percent solids per volume	% solid/volume
107	degrees balling	degrees balling
108	proof per volume	proof/volume
109	proof per mass	proof/mass
110	bushels	bushel
111	cubic yards	cubic yd

Unit Codes	Description from HART Specification	Abbreviated Units
112	cubic feet	cubic ft
113	cubic inches	cubic in
114	inches per second	in/s
115	inches per minute	in/min
116	feet per minute	ft/min
117	degrees per second	°/s
118	revolutions per second	rev/s
119	revolutions per minute	rpm
120	meters per hour	m/hr
121	normal cubic meter per hour	normal cubic m/h
122	normal liter per hour	normal L/h
123	standard cubic feet per minute	standard cubic ft/min
124	bbl liq	bbl liq
125	ounce	oz
126	foot pound force	ft lb force
127	kilo watt	kW
128	kilo watt hour	kW h
129	horsepower	hp
130	cubic feet per hour	cubic ft/h
131	cubic meters per minute	cubic m/min
132	barrels per second	bbl/s
133	barrels per minute	bbl/min
134	barrels per hour	bbl/h
135	barrels per day	bbl/d
136	gallons per hour	usg/h
137	imperial gallons per second	impgal/s
138	liters per hour	L/h
139	parts per million	ppm
140	mega calorie per hour	Mcal/h
141	mega joule per hour	MJ/h
142	british thermal unit per hour	BTU/h
143	degrees	degrees
144	radian	rad
145	inches of water at 15.6 °C (60 °F)	inH2O (15.6 °C or 60 °F)
146	micrograms per liter	micrograms/L
147	micrograms per cubic meter	micrograms/cubic m
148	percent consistency	% consistency
149	volume percent	volume %
150	percent steam quality	% steam quality
151	feet in sixteenths	ft in sixteenths

Unit Codes	Description from HART Specification	Abbreviated Units
152	cubic feet per pound	cubic ft/lb
153	picofarads	pF
154	milliliters per liter	mL/L
155	microliters per liter	microliters/L
156	percent plato	% plato
157	percent lower explosion level	% lower explosion level
158	mega calorie	Mcal
159	Kohms	kohm
160	mega joule	MJ
161	british thermal unit	BTU
162	normal cubic meter	normal cubic m
163	normal liter	normal L
164	standard cubic feet	normal cubic ft
165	parts per billion	parts/billion
235	gallons per day	usg/d
236	hectoliters	hL
237	megapascals	MPa
238	inches of water at 4 °C (39.2 °F)	inH2O (4 °C or 39.2 °F)
239	millimeters of water at 4 °C (39.2 °F)	mmH2O (4 °C or 39.2 °F)

Notes:

Rockwell Automation Support

Rockwell Automation provides technical information on the Web to assist you in using its products.

At <http://www.rockwellautomation.com/support> you can find technical and application notes, sample code, and links to software service packs. You can also visit our Support Center at <https://rockwellautomation.custhelp.com/> for software updates, support chats and forums, technical information, FAQs, and to sign up for product notification updates.

In addition, we offer multiple support programs for installation, configuration, and troubleshooting. For more information, contact your local distributor or Rockwell Automation representative, or visit <http://www.rockwellautomation.com/services/online-phone>.

Installation Assistance

If you experience a problem within the first 24 hours of installation, review the information that is contained in this manual. You can contact Customer Support for initial help in getting your product up and running.

United States or Canada	1.440.646.3434
Outside United States or Canada	Use the Worldwide Locator at http://www.rockwellautomation.com/rockwellautomation/support/overview.page , or contact your local Rockwell Automation representative.

New Product Satisfaction Return

Rockwell Automation tests all of its products to help ensure that they are fully operational when shipped from the manufacturing facility. However, if your product is not functioning and needs to be returned, follow these procedures.

United States	Contact your distributor. You must provide a Customer Support case number (call the phone number above to obtain one) to your distributor to complete the return process.
Outside United States	Please contact your local Rockwell Automation representative for the return procedure.

Documentation Feedback

Your comments will help us serve your documentation needs better. If you have any suggestions on how to improve this document, complete this form, publication [RA-DU002](#), available at <http://www.rockwellautomation.com/literature/>.

Rockwell Automation maintains current product environmental information on its website at <http://www.rockwellautomation.com/rockwellautomation/about-us/sustainability-ethics/product-environmental-compliance.page>

Rockwell Otomasyon Ticaret A.Ş., Kar Plaza İş Merkezi E Blok Kat:6 34752 İçerenköy, İstanbul, Tel: +90 (216) 5698400

www.rockwellautomation.com

Power, Control and Information Solutions Headquarters

Americas: Rockwell Automation, 1201 South Second Street, Milwaukee, WI 53204-2496 USA, Tel: (1) 414.382.2000, Fax: (1) 414.382.4444
Europe/Middle East/Africa: Rockwell Automation NV, Pegasus Park, De Kleetlaan 12a, 1831 Diegem, Belgium, Tel: (32) 2 663 0600, Fax: (32) 2 663 0640
Asia Pacific: Rockwell Automation, Level 14, Core F, Cyberport 3, 100 Cyberport Road, Hong Kong, Tel: (852) 2887 4788, Fax: (852) 2508 1846

Publication 1719-UM001B-EN-E - May 2017

Supersedes Publication 1719-UM001A-EN-E - October 2016

Copyright © 2017 Rockwell Automation, Inc. All rights reserved.